

# TECHNICAL SPECIFICATION

## COLOURS

### COUNTER TOP - GLASS



GLASS LACOBEL,  
WHITE



### FRONT HPL



73 HIGH GLOSS  
WHITE



74 HIGH GLOSS  
ORANGE



80 HIGH GLOSS  
LIME



81 HIGH GLOSS  
BURGUNDY

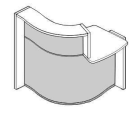
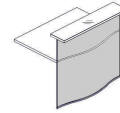

### BODY



67 WHITE PASTEL

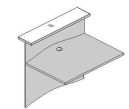
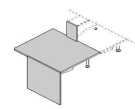

### SUPPORTING LEG WHERE WORKTOPS CONNECT NL41



15 HIGH GLOSS  
WHITE

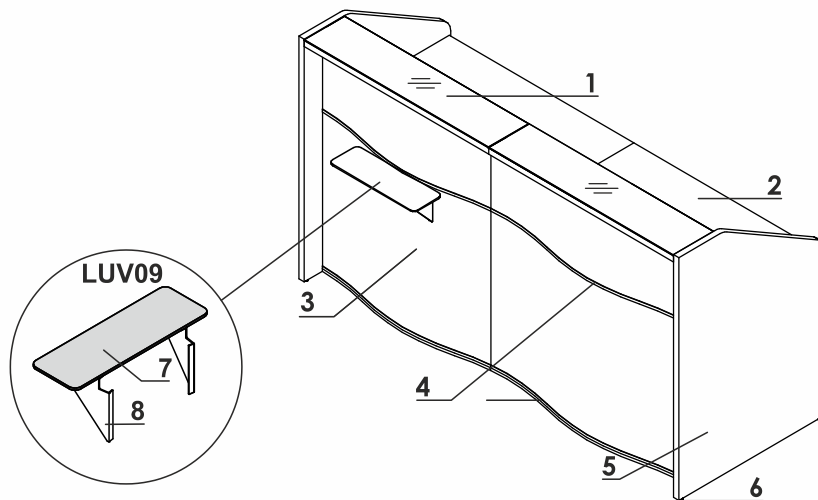

1. **Top** - MFC 28mm + Glass LACOBEL 4mm (32mm)
2. **Work top** - MFC 28mm, PVC edge
3. **Front** - HPL - high gloss
4. **Decorative stripe** - PVC, colour 09-aluminum
5. **Low side panel** - MFC 28mm, PVC edge
6. **Leveling** - 10mm range
7. Shelf for reception counter, HPL mat 6mm
8. **Fixing element** - powder coated metal, color 15 white gloss

## TECHNICAL SPECIFICATION

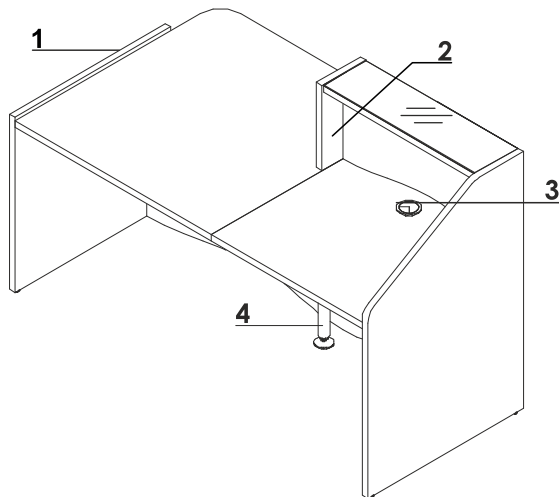

ATTENTION - Interior of the front in white

## ENDING ELEMENTS APPLICATION

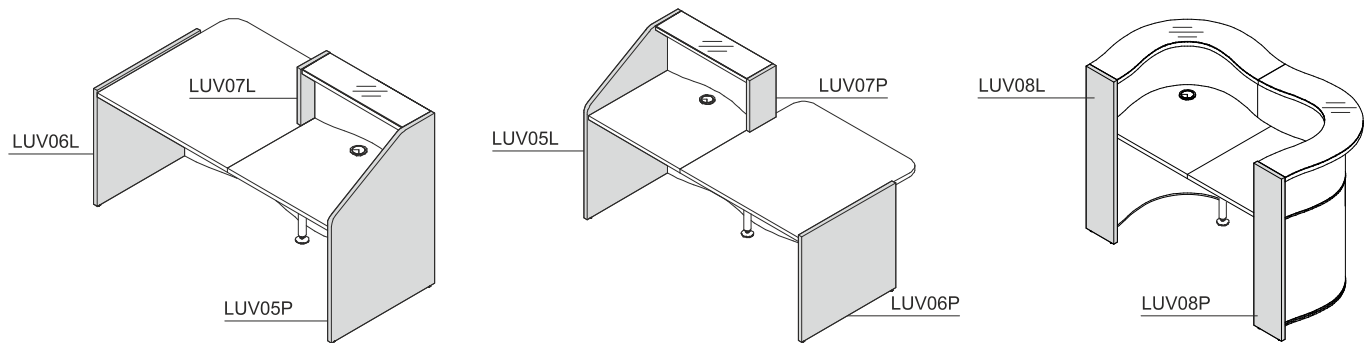

## DIMENSIONS

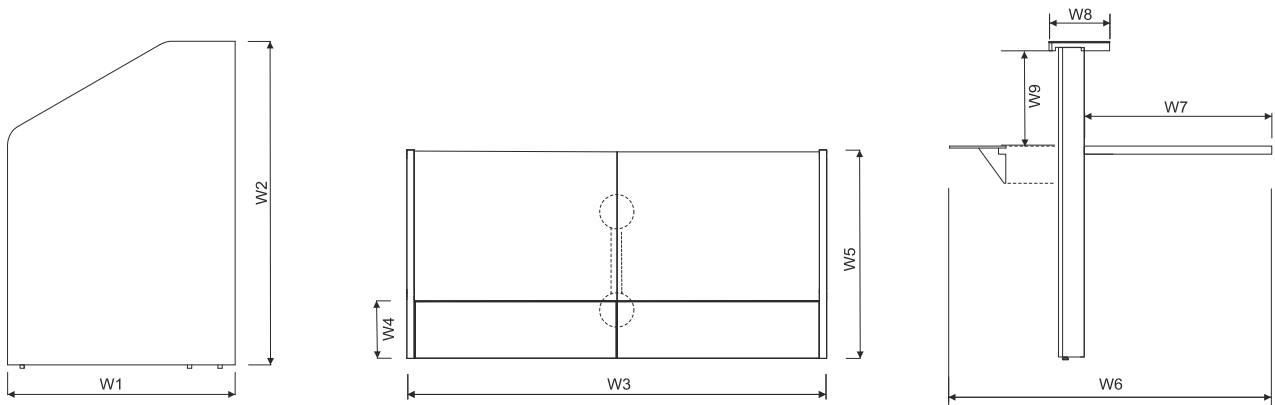

W1 - 770mm | W2 - 1103mm | W3 - 1556mm | W4 - 210mm | W5 - 770mm | W6 - 788mm | W7 - 650mm | W8 - 210mm | W9 - 330mm

**RECEPTION DESKS SYSTEMS**

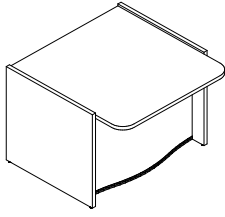

LUV10: LUV06L + LUV01 + LUV06P

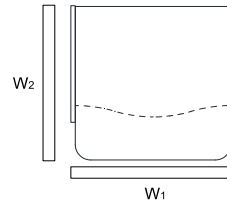

INDEX SYMBOL	DIMENSIONS [mm]						⚖️	📦	📦	COMMENTS
	W <sub>1</sub>	W <sub>2</sub>	D <sub>1</sub>	D <sub>2</sub>	H		kg	m <sup>3</sup>	pcs	
<b>LUV10</b>	1026	1119	-	-	755		50.0	0.167	4	

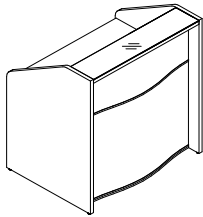

LUV11: LUV05L + LUV03<sup>02</sup> + LUV05P

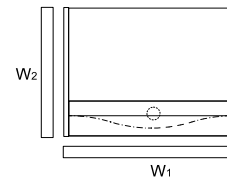

INDEX SYMBOL	DIMENSIONS [mm]						⚖️	📦	📦	COMMENTS
	W <sub>1</sub>	W <sub>2</sub>	D <sub>1</sub>	D <sub>2</sub>	H		kg	m <sup>3</sup>	pcs	
<b>LUV11</b>	806	770	-	-	1103		59.0	0.189	4	
<b>LUV12</b>	1026	770	-	-	1103		63.0	0.226	4	

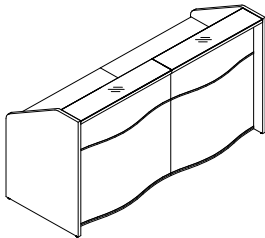

LUV05L + 2xLUV03<sup>02</sup> + LUV05P+NL41

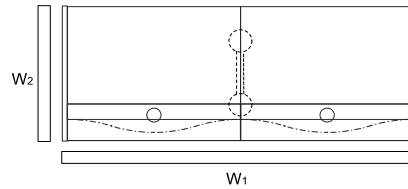

INDEX SYMBOL	DIMENSIONS [mm]						⚖️	📦	📦	COMMENTS
	W <sub>1</sub>	W <sub>2</sub>	D <sub>1</sub>	D <sub>2</sub>	H		kg	m <sup>3</sup>	pcs	
<b>LUV13</b>	1556	770	-	-	1103		90.0	0.380	7	
<b>LUV14</b>	1996	770	-	-	1103		98.0	0.453	7	

DESCRIPTION

⚖️ NET WEIGHT

📦 VOLUME

📦 NUMBER OF PACKAGES

**RECEPTION DESKS SYSTEMS**

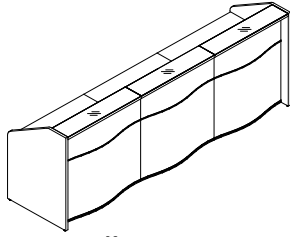

LUV05L + 3xLUV03<sup>02</sup> + LUV05P+2xNL41

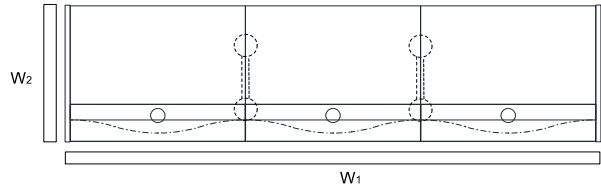

INDEX SYMBOL	DIMENSIONS [mm]									COMMENTS
	W <sub>1</sub>	W <sub>2</sub>	D <sub>1</sub>	D <sub>2</sub>	H		kg	m <sup>3</sup>	pcs	
LUV15	2306	770	-	-	1103		121.0	0.570	10	
LUV16	2966	770	-	-	1103		133.0	0.681	10	

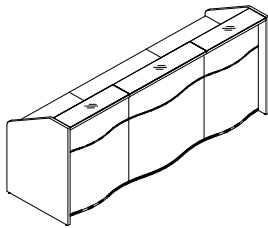

LUV05L + LUV03<sup>02</sup> + 2xLUV02<sup>03</sup> + LUV05P+2xNL41

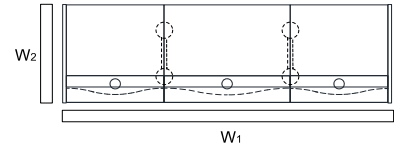
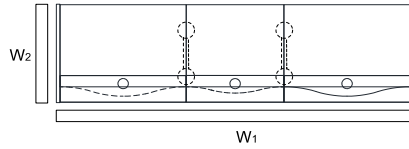

INDEX SYMBOL	DIMENSIONS [mm]									COMMENTS
	W <sub>1</sub>	W <sub>2</sub>	D <sub>1</sub>	D <sub>2</sub>	H		kg	m <sup>3</sup>	pcs	
LUV17	2746	770	-	-	1103		129.0	0.644	10	
LUV18	2526	770	-	-	1103		125.0	0.607	10	

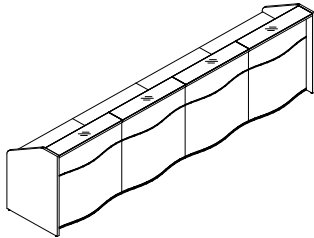

LUV05L + 4xLUV03<sup>02</sup> + LUV05P+3xNL41

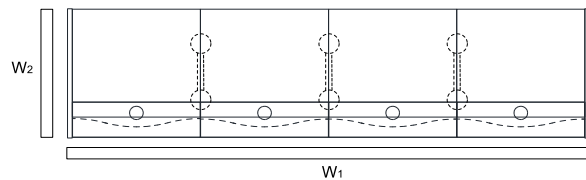

INDEX SYMBOL	DIMENSIONS [mm]									COMMENTS
	W <sub>1</sub>	W <sub>2</sub>	D <sub>1</sub>	D <sub>2</sub>	H		kg	m <sup>3</sup>	pcs	
LUV19	3496	770	-	-	1103		152.0	0.761	13	
LUV20	3936	770	-	-	1103		168.0	0.909	13	

DESCRIPTION

NET WEIGHT

VOLUME

NUMBER OF PACKAGES

**RECEPTION DESKS SYSTEMS**

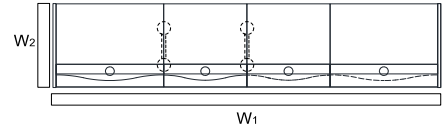
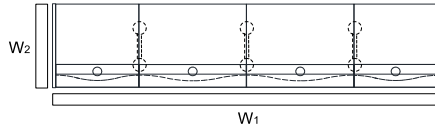
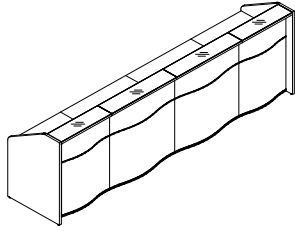

LUV05L + 2xLUV02 + 2xLUV03 + LUV05P+3xNL41

INDEX SYMBOL	DIMENSIONS					[mm]	⚖️	📦	📦	COMMENTS
	W <sub>1</sub>	W <sub>2</sub>	D <sub>1</sub>	D <sub>2</sub>	H					
<b>LUV21</b>	3496	770	-	-	1103		160.0	0.835	13	

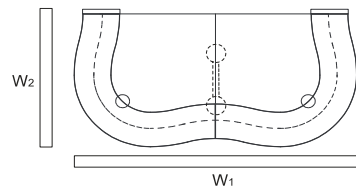
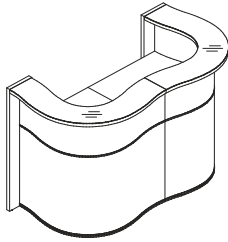

LUV08L + 2xLUV04 + LUV08P

INDEX SYMBOL	DIMENSIONS					[mm]	⚖️	📦	📦	COMMENTS
	W <sub>1</sub>	W <sub>2</sub>	D <sub>1</sub>	D <sub>2</sub>	H					
<b>LUV22</b>	1624	841	-	-	1103		84.0	0.575	7	

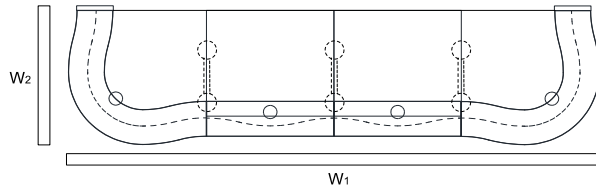
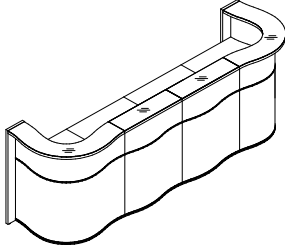

LUV08L + 2xLUV04 + 2xLUV03 + LUV08P+3xNL41

INDEX SYMBOL	DIMENSIONS					[mm]	⚖️	📦	📦	COMMENTS
	W <sub>1</sub>	W <sub>2</sub>	D <sub>1</sub>	D <sub>2</sub>	H					
<b>LUV23</b>	3124	841	-	-	1103		146.0	0.957	13	
<b>LUV24</b>	3564	841	-	-	1103		154.0	1.031	13	

DESCRIPTION

⚖️ NET WEIGHT

📦 VOLUME

📦 NUMBER OF PACKAGES

**RECEPTION DESKS SYSTEMS**

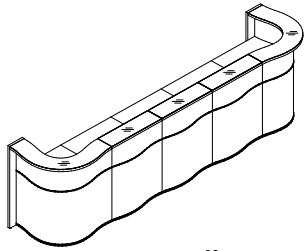

LUV08L + 2xLUV04 + 3xLUV03<sup>02</sup> + LUV08P+4xNL41

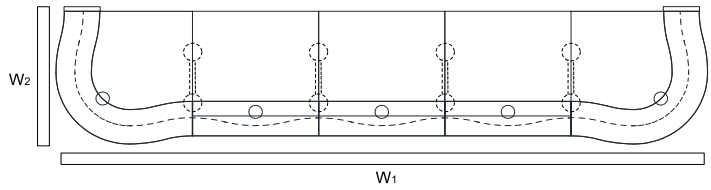

INDEX SYMBOL	DIMENSIONS [mm]						⚖️	📦	📦	COMMENTS
	W <sub>1</sub>	W <sub>2</sub>	D <sub>1</sub>	D <sub>2</sub>	H					
<b>LUV25</b>	3874	841	-	-	1103		177.0	1.148	16	
<b>LUV26</b>	4534	841	-	-	1103		189.0	1.259	16	

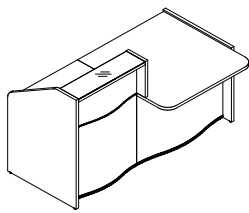

A: LUV05L + LUV03<sup>02</sup> + LUV07P + LUV01 + LUV06P+NL41  
 B: LUV06L + LUV01 + LUV07L + LUV03<sup>02</sup> + LUV05P+NL41

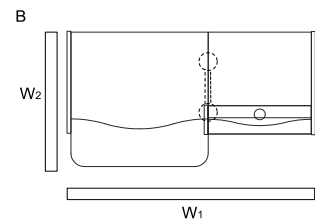
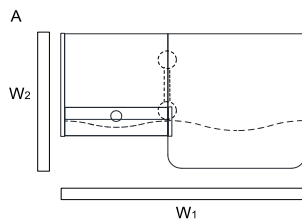

INDEX SYMBOL		DIMENSIONS [mm]						⚖️	📦	📦	COMMENTS
A	B	W <sub>1</sub>	W <sub>2</sub>	D <sub>1</sub>	D <sub>2</sub>	H					
<b>LUV27L</b>	<b>LUV27P</b>	1776	1019	-	-	1103		87.0	0.368	8	
<b>LUV28L</b>	<b>LUV28P</b>	1996	1019	-	-	1103		91.0	0.405	8	

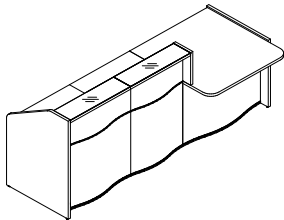

A: LUV05L + 2xLUV03<sup>02</sup> + LUV07P + LUV01 + LUV06P+2xNL41  
 B: LUV06L + LUV01 + LUV07L + 2xLUV03<sup>02</sup> + LUV05P+2xNL41

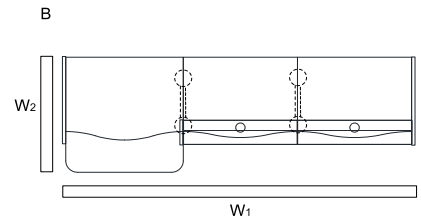
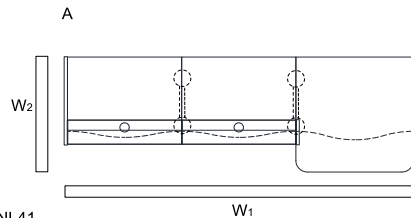

INDEX SYMBOL		DIMENSIONS [mm]						⚖️	📦	📦	COMMENTS
A	B	W <sub>1</sub>	W <sub>2</sub>	D <sub>1</sub>	D <sub>2</sub>	H					
<b>LUV29L</b>	<b>LUV29P</b>	2526	1019	-	-	1103		118.0	0.559	11	
<b>LUV30L</b>	<b>LUV30P</b>	2966	1019	-	-	1103		126.0	0.633	11	

DESCRIPTION

⚖️ NET WEIGHT

📦 VOLUME

📦 NUMBER OF PACKAGES

**RECEPTION DESKS SYSTEMS**

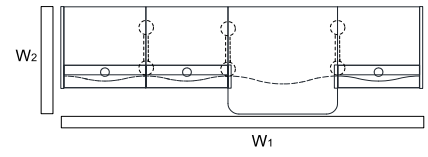
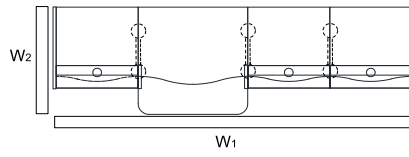
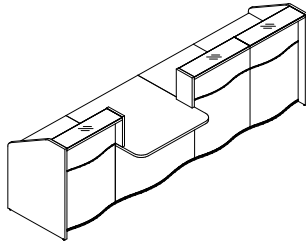

LUV05L + 2xLUV03<sup>02</sup> + LUV07P + LUV01 + LUV07L + LUV03<sup>02</sup> + LUV05P+3xNL41

INDEX SYMBOL	DIMENSIONS [mm]						⚖️	📦	📦		COMMENTS
	W <sub>1</sub>	W <sub>2</sub>	D <sub>1</sub>	D <sub>2</sub>	H						
LUV31	3276	1019	-	-	1103		155.0	0.759	15		
LUV32	3936	1019	-	-	1103		167.0	0.870	15		

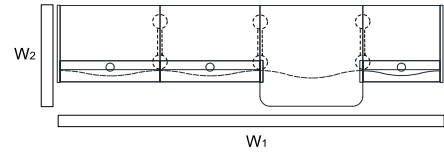
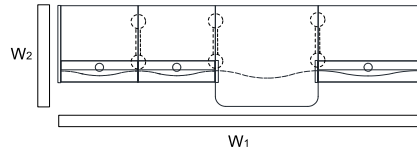
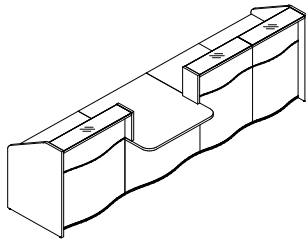

LUV5L + LUV02<sup>03</sup> + LUV07P + LUV01 + LUV07L + 2xLUV03<sup>02</sup> + LUV05P+3xNL41

INDEX SYMBOL	DIMENSIONS [mm]						⚖️	📦	📦		COMMENTS
	W <sub>1</sub>	W <sub>2</sub>	D <sub>1</sub>	D <sub>2</sub>	H						
LUV33	3496	1019	-	-	1103		159.0	0.796	15		
LUV34	3716	1019	-	-	1103		163.0	0.833	15		

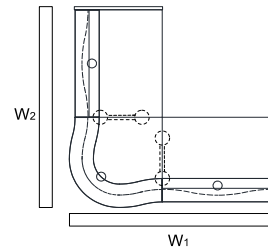
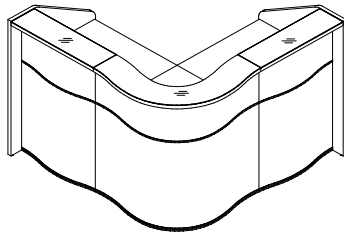

LUV5L + LUV03<sup>02</sup> + LUV04 + LUV03<sup>02</sup> + LUV05P+2xNL41

INDEX SYMBOL	DIMENSIONS [mm]						⚖️	📦	📦		COMMENTS
	W <sub>1</sub>	W <sub>2</sub>	D <sub>1</sub>	D <sub>2</sub>	H						
LUV35	1590	1590	-	-	1103		128.0	0.689	10		
LUV36	1810	1810	-	-	1103		136.0	0.763	10		

DESCRIPTION

⚖️ NET WEIGHT

📦 VOLUME

📦 NUMBER OF PACKAGES

**RECEPTION DESKS SYSTEMS**

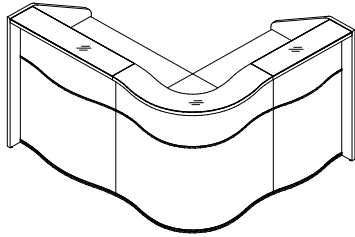

LUV05L + LUV03 + LUV04 + LUV02 + LUV05P+2xNL41

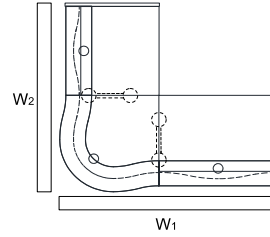

INDEX SYMBOL	DIMENSIONS					[mm]	⚖️	📦	📦		COMMENTS
	W <sub>1</sub>	W <sub>2</sub>	D <sub>1</sub>	D <sub>2</sub>	H	kg					
<b>LUV37</b>	1810	1590	-	-	1103		132.0	0.726	10		

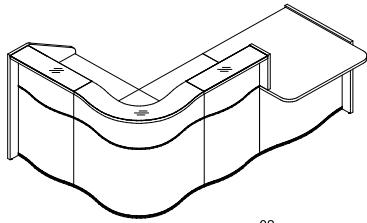

A: LUV06L + LUV01 + LUV07L + LUV03<sup>02</sup> + LUV04 + LUV03<sup>02</sup> + LUV05P+3xNL41  
 B: LUV05L + LUV03<sup>02</sup> + LUV04 + LUV03<sup>02</sup> + LUV07P + LUV01 + LUV06P+3xNL41

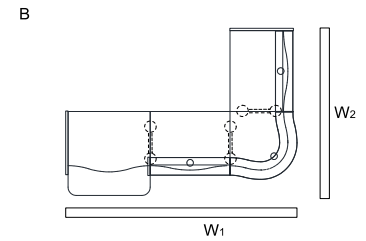
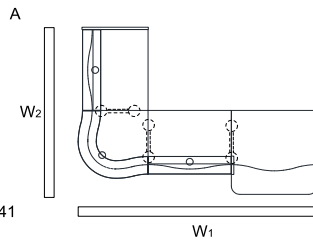

INDEX SYMBOL		DIMENSIONS					[mm]	⚖️	📦	📦		COMMENTS
A	B	W <sub>1</sub>	W <sub>2</sub>	D <sub>1</sub>	D <sub>2</sub>	H	kg					
<b>LUV38L</b>	<b>LUV38P</b>	2560	1590	-	-	1103		156.0	0.868	14		
<b>LUV39L</b>	<b>LUV39P</b>	2780	1810	-	-	1103		164.0	0.942	14		

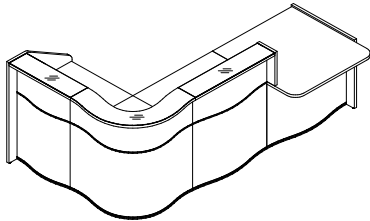

A: LUV06L + LUV01 + LUV07L + LUV03 + LUV04 + LUV02 + LUV05P+3xNL41  
 B: LUV05L + LUV02 + LUV04 + LUV03 + LUV07P + LUV01 + LUV06P+3xNL41

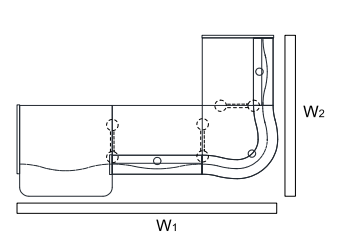
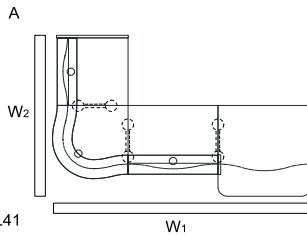

INDEX SYMBOL		DIMENSIONS					[mm]	⚖️	📦	📦		COMMENTS
A	B	W <sub>1</sub>	W <sub>2</sub>	D <sub>1</sub>	D <sub>2</sub>	H	kg					
<b>LUV40L</b>	<b>LUV40P</b>	2780	1792	-	-	1103		160.0	0.905	14		

DESCRIPTION

⚖️ NET WEIGHT

📦 VOLUME

📦 NUMBER OF PACKAGES



**RECEPTION DESKS SYSTEMS**

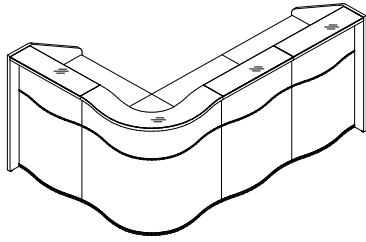

LUV05L + 2xLUV03<sup>02</sup> + LUV04 + LUV03<sup>02</sup> + LUV05P+3xNL41

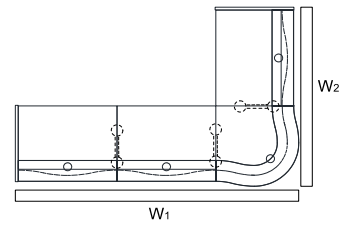
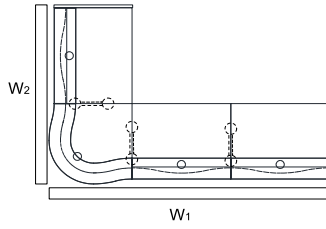

INDEX SYMBOL	DIMENSIONS [mm]						⚖️	📦	📦		COMMENTS
	W <sub>1</sub>	W <sub>2</sub>	D <sub>1</sub>	D <sub>2</sub>	H						
<b>LUV41</b>	2340	1590	-	-	1103		159.0	0.879	13		
<b>LUV42</b>	2780	1810	-	-	1103		171.0	0.990	13		

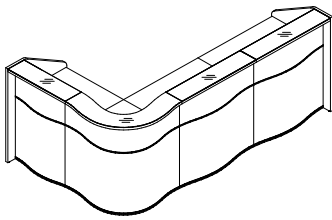

LUV05L + LUV03<sup>02</sup> + LUV04 + 2xLUV02<sup>03</sup> + LUV05P+3xNL41

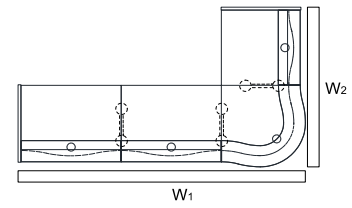
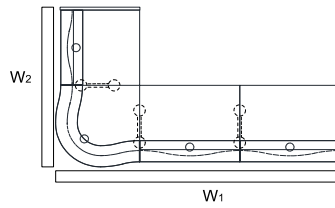

INDEX SYMBOL	DIMENSIONS [mm]						⚖️	📦	📦		COMMENTS
	W <sub>1</sub>	W <sub>2</sub>	D <sub>1</sub>	D <sub>2</sub>	H						
<b>LUV43</b>	2780	1792	-	-	1103		167.0	0.953	13		
<b>LUV44</b>	2343	1813	-	-	1103		163.0	0.916	13		

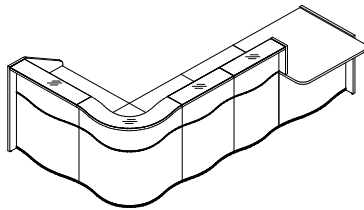

A: LUV06L + LUV01 + LUV07L + 2xLUV03<sup>02</sup> + LUV04 + LUV03<sup>02</sup> + LUV05P+4xNL41  
 B: LUV05L + LUV03<sup>02</sup> + LUV04 + 2xLUV03<sup>02</sup> + LUV07P + LUV01 + LUV06P+4xNL41

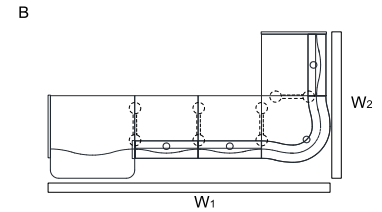
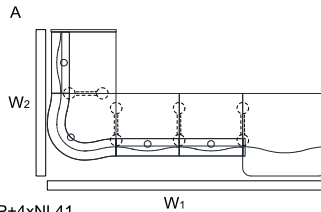

INDEX SYMBOL		DIMENSIONS [mm]						⚖️	📦	📦		COMMENTS
A	B	W <sub>1</sub>	W <sub>2</sub>	D <sub>1</sub>	D <sub>2</sub>	H						
<b>LUV45L</b>	<b>LUV45P</b>	3310	1792	-	-	1103		187.0	1.059	17		
<b>LUV46L</b>	<b>LUV46P</b>	3750	1810	-	-	1103		199.0	1.169	17		

DESCRIPTION

⚖️ NET WEIGHT

📦 VOLUME

📦 NUMBER OF PACKAGES

**RECEPTION DESKS SYSTEMS**

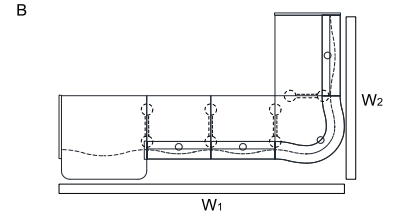
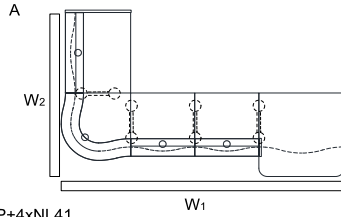
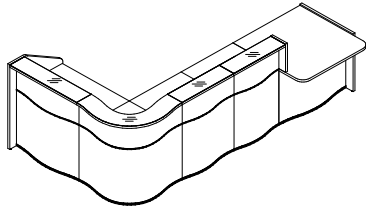

A: LUV06L + LUV01 + LUV07L + 2xLUV03<sup>02</sup> + LUV04 + LUV02 + LUV05P+4xNL41  
 B: LUV05L + LUV02<sup>03</sup> + LUV04 + 2xLUV03<sup>02</sup> + LUV07P + LUV01 + LUV06P+4xNL41

INDEX SYMBOL		DIMENSIONS [mm]						⚖️	📦	📦		COMMENTS
A	B	W <sub>1</sub>	W <sub>2</sub>	D <sub>1</sub>	D <sub>2</sub>	H						
<b>LUV47L</b>	<b>LUV47P</b>	3310	1810	-	-	1103		195.0	1.133	17		
<b>LUV48L</b>	<b>LUV48P</b>	3750	1792	-	-	1103		191.0	1.096	17		

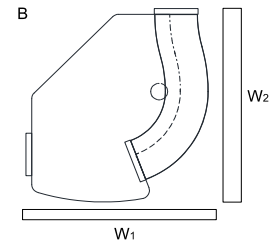
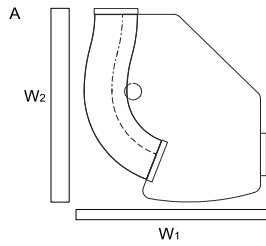
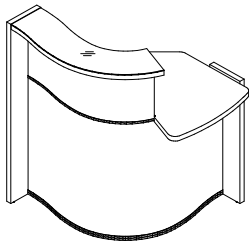





INDEX SYMBOL		DIMENSIONS [mm]						⚖️	📦	📦		COMMENTS
A	B	W <sub>1</sub>	W <sub>2</sub>	D <sub>1</sub>	D <sub>2</sub>	H						
<b>LUV49L</b>	<b>LUV49P</b>	858	925	-	-	1103		39.0	0.231	2		

DESCRIPTION



⚖️ NET WEIGHT

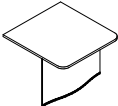
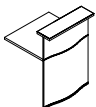
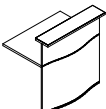
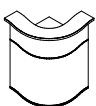
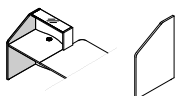
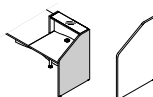
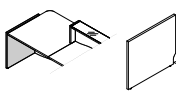
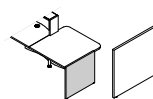

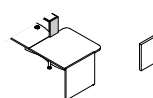
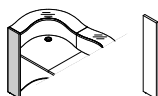
📦 VOLUME

📦 NUMBER OF PACKAGES



PRODUCT ILLUSTRATION	DIMENSIONS [mm]			INDEX SYMBOL						COMMENTS
	WIDTH	DEPTH	HEIGHT			kg	m3	pcs		
<b>COMPOSITION ELEMENTS</b>										
	970	1015	740	LUV01		28.0	0.118	2		
	750	763	1103	LUV02		29.0	0.128	2		
	970	763	1103	LUV03		33.0	0.165	2		
	815	815	1103	LUV04		36.0	0.246	2		
	770	28	1103	LUV05L		15.0	0.030	1		left
	770	28	1103	LUV05P		15.0	0.030	1		right
	770	28	755	LUV06L		11.0	0.024	1		left
	770	28	755	LUV06P		11.0	0.024	1		right
	216	28	363	LUV07L		2.0	0.004	1		left
	216	28	363	LUV07P		2.0	0.004	1		right
	216	28	1103	LUV08L		5.0	0.010	1		left

DESCRIPTION

 NET WEIGHT VOLUME NUMBER OF PACKAGES

PRODUCT ILLUSTRATION	DIMENSIONS [mm]			INDEX SYMBOL						COMMENTS
	WIDTH	DEPTH	HEIGHT			kg	m3	pcs		

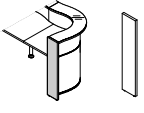
**COMPOSITION ELEMENTS**

	216	28	1103	<b>LUV08P</b>		5.0	0.010	1		right
	470	170	170	<b>LUV09</b>		0.0	0.000	0		67-white pastel
	585	142	712	<b>NL41</b>		2.0	0.063	1		round profile leg

DESCRIPTION

 NET WEIGHT

 VOLUME

 NUMBER OF PACKAGES