

# TECHNICAL SPECIFICATION

## COLOURS

### COUNTER TOP, WORKTOP



26 ALUMINUM SATINATO



GLASS LACOBEL, SILVER

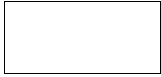

67 WHITE PASTEL

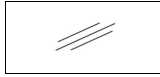

GLASS LACOBEL, WHITE



### FRONT HPL



31 CANADIAN OAK

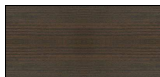

34 CHESTNUT

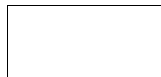

73 HIGH GLOSS WHITE



74 HIGH GLOSS ORANGE



80 HIGH GLOSS LIME



81 HIGH GLOSS BURGUNDY



102 HIGH GLOSS YELLOW



108 BLUE HIGH GLOSS



127 HIGH GLOSS FUCHSIA

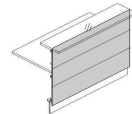

### INTERIOR



67 WHITE PASTEL

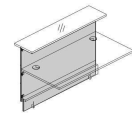

### HPL ELEMENTS STRUCTURE

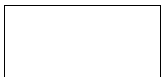

73 HIGH GLOSS WHITE



148 HIGH GLOSS GRAY

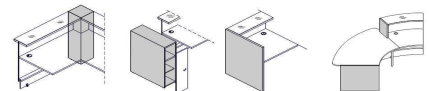

### FRONT LAD10



26 ALUMINUM SATINATO



67 WHITE PASTEL

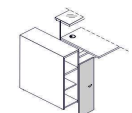

### SUPPORTING LEG WHERE WORKTOPS CONNECT NL41

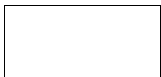

15 HIGH GLOSS WHITE



### STACK-ON WORKTOP STORAGE FOR RECEPTION DESK



08 BLACK



26 ALUMINUM SATINATO



67 WHITE PASTEL



## TECHNICAL SPECIFICATION

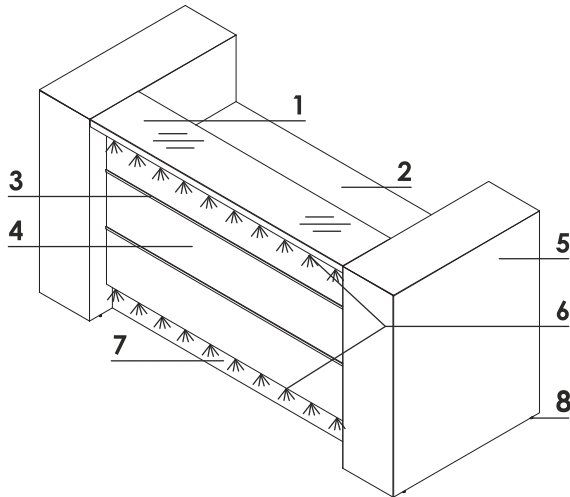

1. **Top** - MFC 28mm + Glass LACOBEL 4mm (32mm)
2. **Worktop** - MFC 28mm, PVC edge
3. **Decorative stripe** - PVC, colour 09-aluminum
4. **Front** - HPL - high gloss
5. **Storage as ending element** - MFC 18mm, PVC edge
6. **LED Lighting** - white
7. **Kick plate** - HPL - brushed aluminium
8. **Leveling** - 5mm range

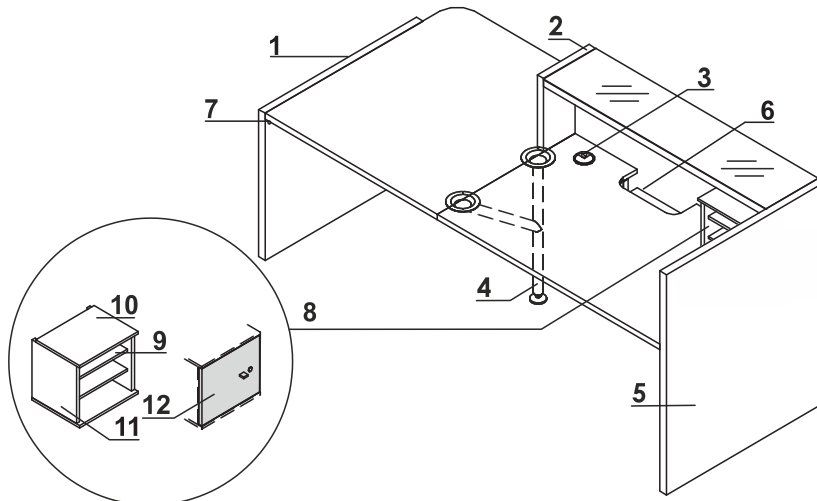

1. **Low side panel** -HPL high gloss - 38mm
2. **Side panel linking low and high fronts** - HPL high gloss - 38mm
3. **Cable grommets** - Ø80mm
4. **Supporting leg NE41**- required for connecting the tops
5. **High side panel** - HPL high gloss - 38mm
6. **Option with additional charge** - working top with lowered monitor shelf - MFC 28mm, PVC edge
7. Light swich
8. **LMS05** - reception desk storage; order separately
9. **Shelf** - MFC 18mm, PVC edge
10. **Top** - MFC 12mm, PVC edge
11. **Body** - MFC 18mm, PVC edge
12. **Optional front with lock** - universal (left, right) - MFC 18mm, PVC edge; - ordered as separate element

ATTENTION - Interior of the front in white

## ENDING STORAGE

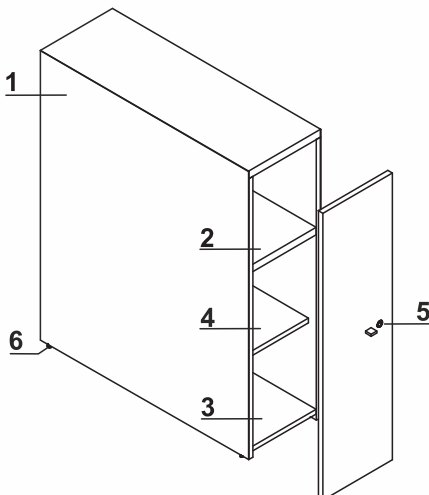

1. **Storage as ending element** - MFC 18mm, PVC edge
2. **Shelf** - MFC 28mm, PVC edge
3. **Base** - MFC 18mm, PVC edge
4. Shelf with possibility of height regulation, MFC 18mm, PVC edge
5. **Front** - HPL - high gloss 38mm
6. **Leveling** - 5mm range

# TECHNICAL SPECIFICATION

## ENDING ELEMENTS APPLICATION

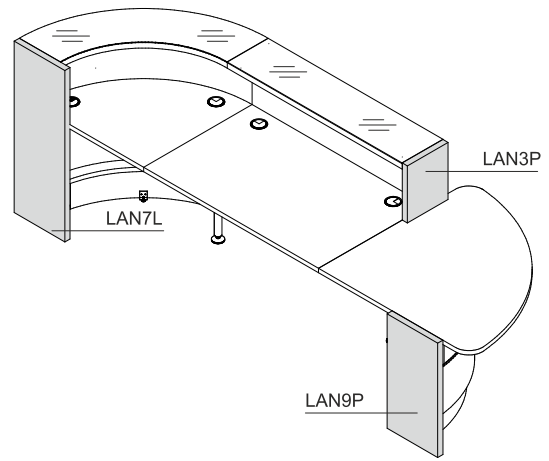
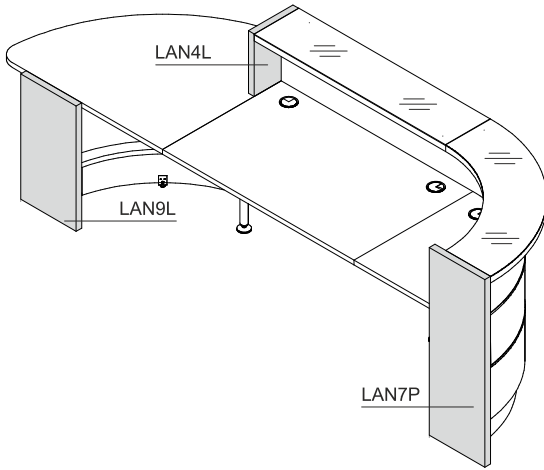
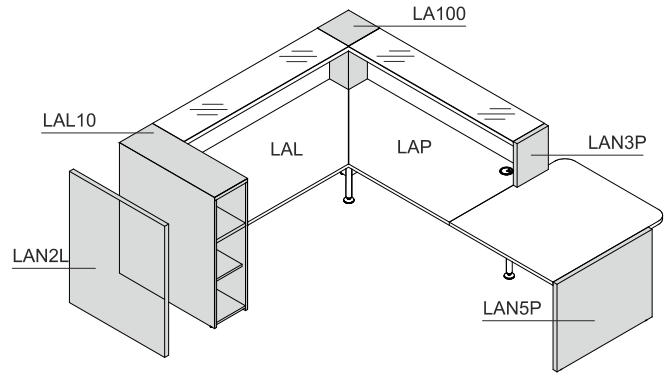
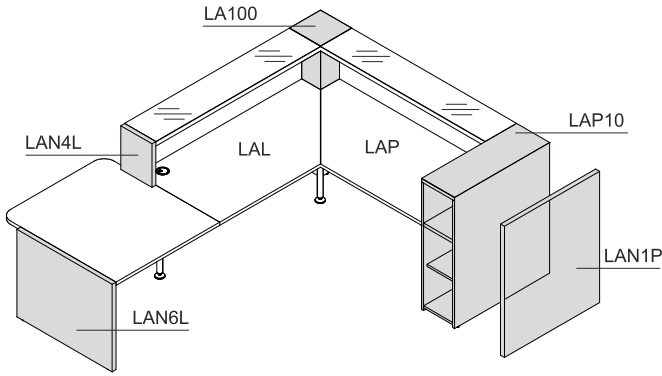

### DIMENSIONS

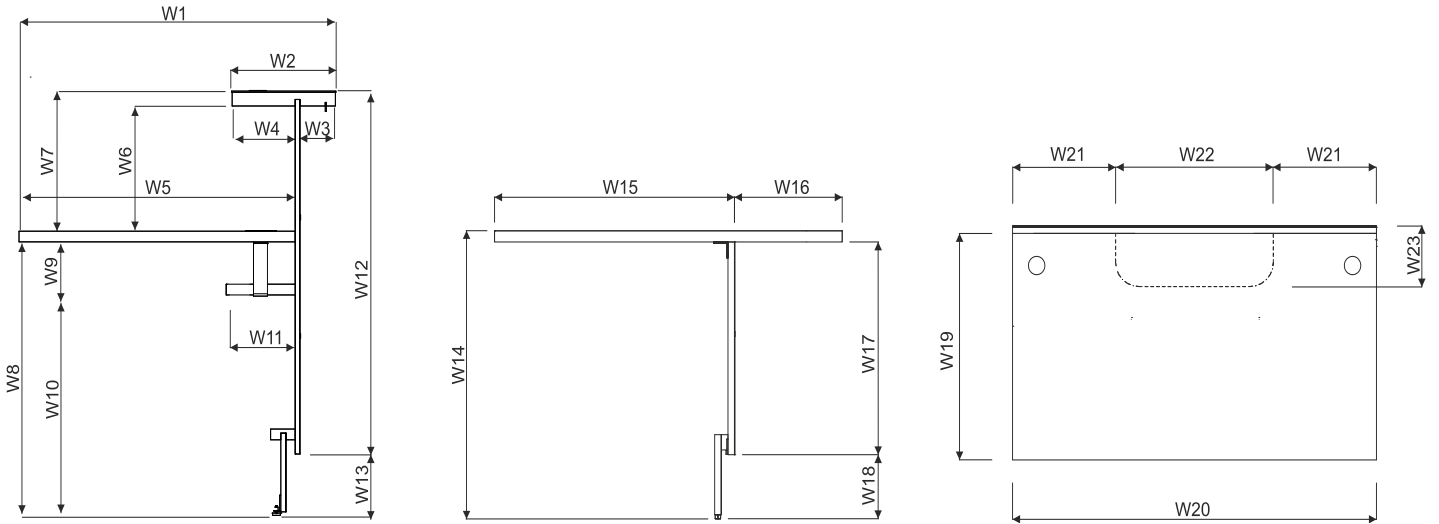

W1 - 916mm | W2 - 300mm | W3 - 103mm | W4 - 183mm | W5 - 800mm | W6 - 324mm | W7 - 364mm | W8 - 712mm | W9 - 138mm | W10 - 574mm |  
W11 - 200mm | W12 - 944mm | W13 - 150mm | W14 - 740mm | W15 - 814mm | W16 - 300mm | W17 - 580mm | W18 - 160mm | W19 - 800mm | W20 -  
1290/1590/2290mm | W21 - 385/535/885mm | W22 - 520mm | W23 - 200mm

**RECEPTION DESKS SYSTEMS**

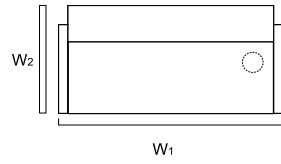
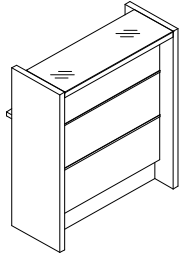

INDEX SYMBOL	DIMENSIONS [mm]									COMMENTS
	W <sub>1</sub>	W <sub>2</sub>	D <sub>1</sub>	D <sub>2</sub>	H		kg	m <sup>3</sup>	pcs	
<b>LAV96L</b>	920	454	-	-	1105		51.5	0.182	7	

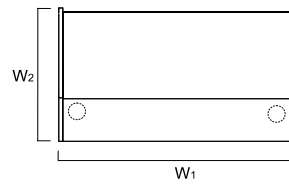
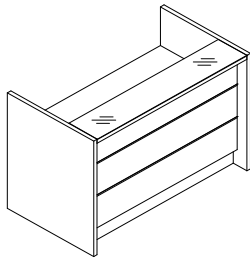

09  
13  
16  
LAN1P+LA23L+LAN2L

INDEX SYMBOL	DIMENSIONS [mm]									COMMENTS
	W <sub>1</sub>	W <sub>2</sub>	D <sub>1</sub>	D <sub>2</sub>	H		kg	m <sup>3</sup>	pcs	
<b>LAV95L</b> <sup>09</sup>	920	917	-	-	1105		88.0	0.252	6	
<b>LAV75L</b> <sup>13</sup>	1366	917	-	-	1105		127.6	0.369	8	
<b>LAV76L</b> <sup>16</sup>	1666	917	-	-	1105		145.5	0.424	8	
<b>LAV77L</b> <sup>23</sup>	2366	917	-	-	1105		182.0	0.584	9	

DESCRIPTION

NET WEIGHT

VOLUME

NUMBER OF PACKAGES

**RECEPTION DESKS SYSTEMS**

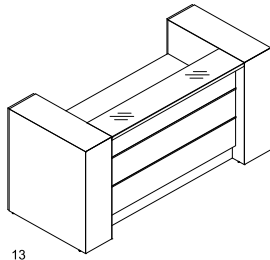

<sup>13</sup>  
<sup>16</sup>  
LAD10+LAP10+LA23L+LAL10+LAD10

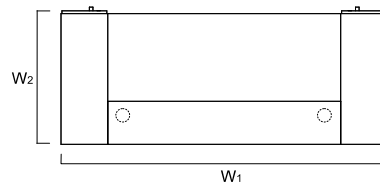

INDEX SYMBOL	DIMENSIONS [mm]						⚖️	📦	📦		COMMENTS
	W <sub>1</sub>	W <sub>2</sub>	D <sub>1</sub>	D <sub>2</sub>	H						
<sup>13</sup> <b>LAV01L</b>	1926	937	-	-	1105		184.6	1.016	10		
<sup>16</sup> <b>LAV02L</b>	2226	937	-	-	1105		202.5	1.072	10		
<sup>23</sup> <b>LAV03L</b>	2926	937	-	-	1105		239.0	1.231	11		

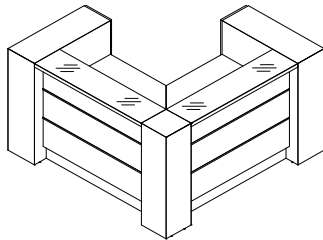

<sup>13</sup>  
<sup>16</sup>  
LAD10+LAP10+LAP23L+LA100+NL41+LAL16L+LAL10+LAD10

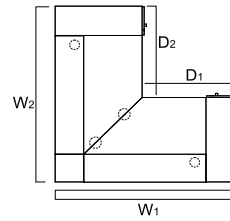

INDEX SYMBOL	DIMENSIONS [mm]						⚖️	📦	📦		COMMENTS
	W <sub>1</sub>	W <sub>2</sub>	D <sub>1</sub>	D <sub>2</sub>	H						
<sup>13</sup> <b>LAV10L</b>	1908	1908	991	991	1105		241.4	1.380	15		
<sup>16</sup> <b>LAV11L</b>	1908	2208	991	1291	1105		261.3	1.437	17		
<sup>23</sup> <b>LAV12L</b>	1908	2908	991	1991	1105		287.8	1.577	18		
<sup>13</sup> <b>LAV13L</b>	2208	1908	1291	991	1105		261.3	1.437	17		
<sup>16</sup> <b>LAV14L</b>	2208	2208	1291	1291	1105		269.2	1.474	15		
<sup>23</sup> <b>LAV15L</b>	2208	2908	1291	1991	1105		301.7	1.624	18		

DESCRIPTION

⚖️ NET WEIGHT

📦 VOLUME

📦 NUMBER OF PACKAGES

**RECEPTION DESKS SYSTEMS**

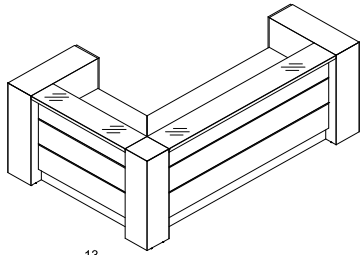

LAD10+LAP10+LAP<sup>13</sup><sub>23L</sub>+LA100+NL41+LAL23L+LAL10+LAD10

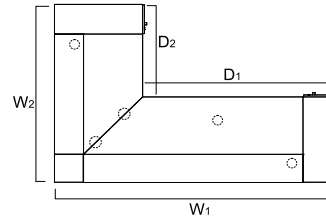

INDEX SYMBOL	DIMENSIONS [mm]						⚖️	📦	📦		COMMENTS
	W <sub>1</sub>	W <sub>2</sub>	D <sub>1</sub>	D <sub>2</sub>	H						
23 <b>LAV16L</b> <sup>13</sup>	2908	1908	1991	991	1105		287.8	1.577	18		
23 <b>LAV17L</b> <sup>16</sup>	2908	2208	1991	1291	1105		301.7	1.624	18		
23 <b>LAV18L</b> <sup>23</sup>	2908	2908	1991	1991	1105		322.2	1.752	17		

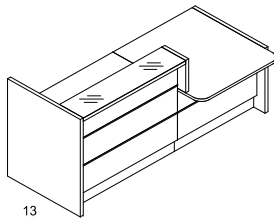

A: LAN1P+LA23L+NL41+LAN4L+LAU11L+LAN6L

B: LAN5P+LAU11L+NL41+LAN3P+LA23L+LAN2L

A

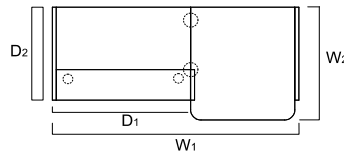

B

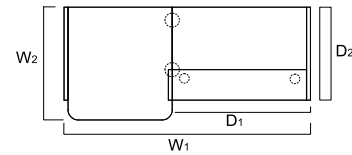

INDEX SYMBOL	DIMENSIONS [mm]						⚖️	📦	📦		COMMENTS
	W <sub>1</sub>	W <sub>2</sub>	D <sub>1</sub>	D <sub>2</sub>	H						
A <b>LAV19L</b> <sup>13</sup>	2366	1114	1328	917	1105		138.9	0.509	12		
B <b>LAV20L</b> <sup>13</sup>	2366	1114	1328	917	1105		138.9	0.509	12		
A <b>LAV21L</b> <sup>16</sup>	2666	1114	1628	917	1105		152.3	0.556	12		
B <b>LAV22L</b> <sup>16</sup>	2666	1104	1628	917	1105		152.3	0.556	12		
A <b>LAV23L</b> <sup>23</sup>	3366	1114	2318	917	1105		178.8	0.695	13		
B <b>LAV24L</b> <sup>23</sup>	3366	1114	2318	917	1105		178.8	0.695	13		

DESCRIPTION

⚖️ NET WEIGHT

📦 VOLUME

📦 NUMBER OF PACKAGES

**RECEPTION DESKS SYSTEMS**

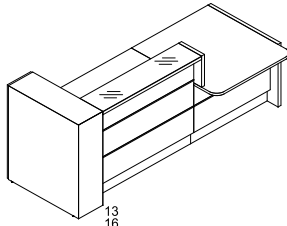

A

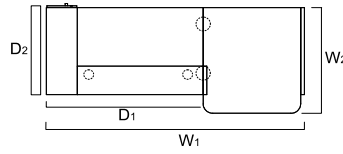

B

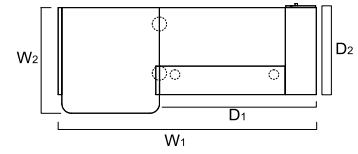

A: LAD10+LAP10+LA23L+NL41+LAN4L+LAU11L+LAN6L

B: LAN5P+LAU11L+NL41+LAN3P+LA23L+LAL10+LAD10

INDEX SYMBOL	DIMENSIONS [mm]						⚖️	📦	📦		COMMENTS
	W <sub>1</sub>	W <sub>2</sub>	D <sub>1</sub>	D <sub>2</sub>	H						
A <b>LAV41L</b> <sup>13</sup>	2646	1134	1608	937	1105		167.4	0.833	13		
B <b>LAV42L</b> <sup>13</sup>	2646	1134	1608	937	1105		167.4	0.833	13		
A <b>LAV43L</b> <sup>16</sup>	2946	1134	1908	937	1105		180.8	0.880	13		
B <b>LAV44L</b> <sup>16</sup>	2946	1134	1908	937	1105		180.8	0.880	13		
A <b>LAV45L</b> <sup>23</sup>	3646	1134	2608	937	1105		207.3	1.019	14		
B <b>LAV46L</b> <sup>23</sup>	3646	1134	2608	937	1105		207.3	1.019	14		

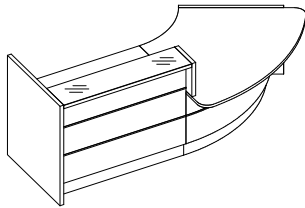

A

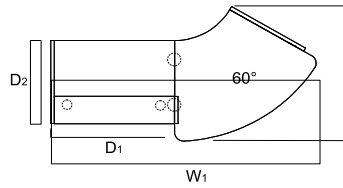

B

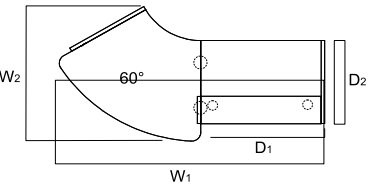

A: LAN1P+LA16L+NL41+LAN4L+LAV66L+LAN6L

B: LAN5P+LAV66L+NL41+LAN3P+LA16L+LAN2L

INDEX SYMBOL	DIMENSIONS [mm]						⚖️	📦	📦		COMMENTS
	W <sub>1</sub>	W <sub>2</sub>	D <sub>1</sub>	D <sub>2</sub>	H						
A <b>LAV88L</b> <sup>13</sup>	2845	1486	1328	917	1105		160.9	0.832	12		
B <b>LAV89L</b> <sup>13</sup>	2845	1486	1328	917	1105		160.9	0.832	12		
A <b>LAV91L</b> <sup>16</sup>	3145	1486	1628	917	1105		174.3	0.879	12		
B <b>LAV92L</b> <sup>16</sup>	3145	1486	1628	917	1105		174.3	0.879	12		

DESCRIPTION

⚖️ NET WEIGHT

📦 VOLUME

📦 NUMBER OF PACKAGES

**RECEPTION DESKS SYSTEMS**

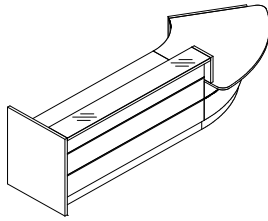

A: LAN1P+LA23L+NL41+LAN4L+LAV66L+LAN6L

B: LAN5P+LAV66L+NL41+LAN3P+LA23L+LAN2L

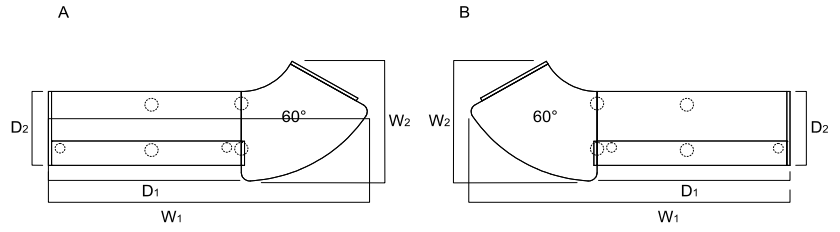

INDEX SYMBOL	DIMENSIONS [mm]						⚖️	📦	📦		COMMENTS
	W <sub>1</sub>	W <sub>2</sub>	D <sub>1</sub>	D <sub>2</sub>	H						
A <b>LAV93L</b> <sup>23</sup>	3845	1486	2318	917	1105		200.8	1.018	13		
B <b>LAV94L</b> <sup>23</sup>	3845	1486	2318	917	1105		200.8	1.018	13		

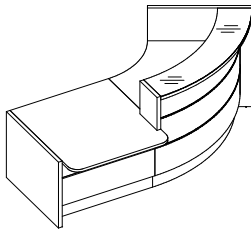

A: LAN5P+LAU11L+NL41+LAN3P+LAV64L+LAN2L

B: LAN1P+LAV64L+NL41+LAN4L+LAU11L+LAN6L

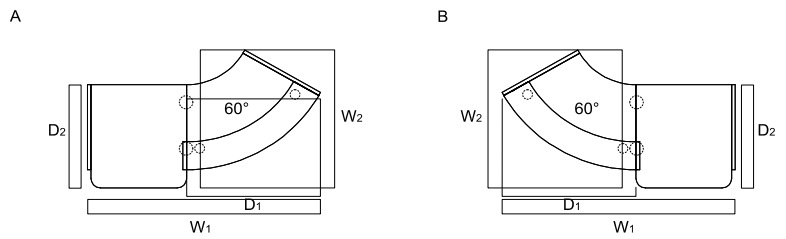

INDEX SYMBOL	DIMENSIONS [mm]						⚖️	📦	📦		COMMENTS
	W <sub>1</sub>	W <sub>2</sub>	D <sub>1</sub>	D <sub>2</sub>	H						
A <b>LAV84L</b>	2443	1489	1404	1114	1105		149.8	0.957	12		
B <b>LAV85L</b>	2443	1489	1404	1114	1105		149.8	0.957	12		

DESCRIPTION

⚖️ NET WEIGHT

📦 VOLUME

📦 NUMBER OF PACKAGES



**RECEPTION DESKS SYSTEMS**

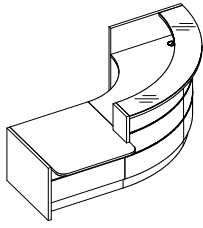

A

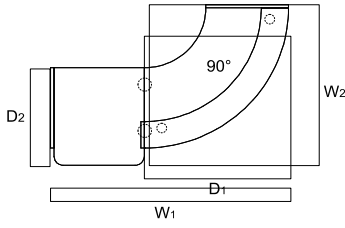

B

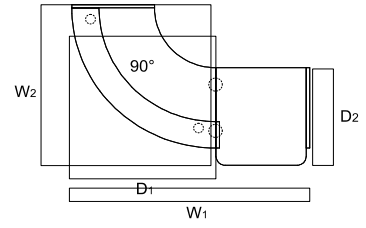

A: LAN5P+LAU11L+NL41+LAN3P+LAV90L+LAN2L  
 B: LAN1P+LAV90L+NL41+LAN4L+LAU11L+LAN6L

INDEX SYMBOL	DIMENSIONS [mm]						⚖️	📦	📦		COMMENTS
	W <sub>1</sub>	W <sub>2</sub>	D <sub>1</sub>	D <sub>2</sub>	H						
A <b>LAV86L</b>	2638	1835	1600	937	1105		190.8	1.328	13		
B <b>LAV87L</b>	2638	1835	-	-	1105		190.8	1.328	13		

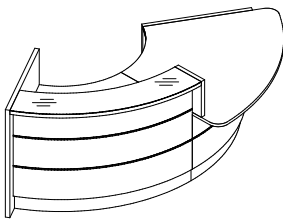

A

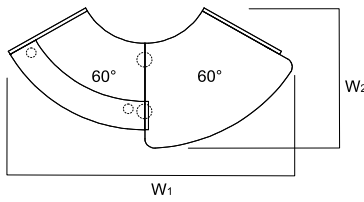

B

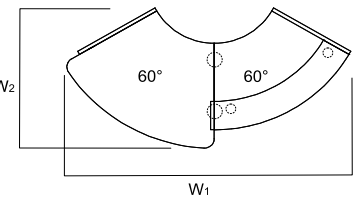

A: LAN1P+LAV64L+NL41+LAN4L+LAV66L+LAN6L  
 B: LAN5P+LAV66L+NL41+LAN3P+LAV64L+LAN2L

INDEX SYMBOL	DIMENSIONS [mm]						⚖️	📦	📦		COMMENTS
	W <sub>1</sub>	W <sub>2</sub>	D <sub>1</sub>	D <sub>2</sub>	H						
A <b>LAV30L</b>	2922	1486	-	-	1105		171.8	1.280	12		
B <b>LAV31L</b>	2922	1486	-	-	1105		171.8	1.280	12		

DESCRIPTION

⚖️ NET WEIGHT

📦 VOLUME

📦 NUMBER OF PACKAGES

**RECEPTION DESKS SYSTEMS**

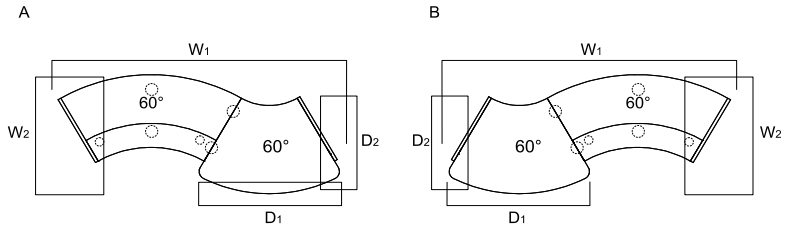
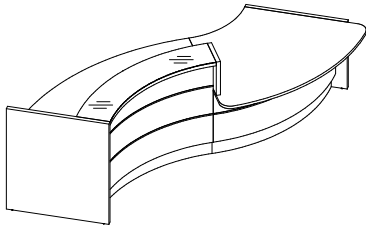

A: LAN1P+LAV62L+NL41+LAN4L+LAV66L+LAN6L  
 B: LAN5P+LAV66L+NL41+LAN3P+LAV62L+LAN2L

INDEX SYMBOL	DIMENSIONS					[mm]	⚖️	📦	📦		COMMENTS
	W <sub>1</sub>	W <sub>2</sub>	D <sub>1</sub>	D <sub>2</sub>	H						
A <b>LAV32L</b>	3452	1502	1720	1225	1105		182.8	1.366	13		
B <b>LAV33L</b>	3452	1502	-	-	1105		182.8	1.366	13		

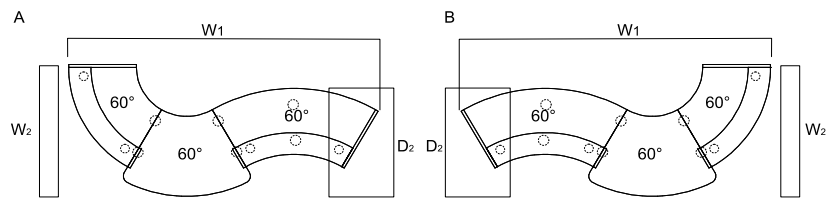
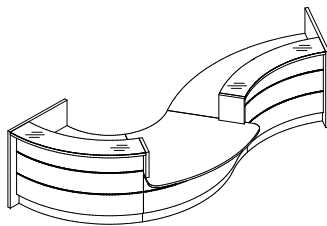

A: LAN1P+LAV64L+NL41+LAN4L+LAV66L+NL41+LAN3P+LAV62L+LAN2L  
 B: LAN1P+LAV62L+NL41+LAN4L+LAV66L+NL41+LAN3P+LAV64L+LAN2L

INDEX SYMBOL	DIMENSIONS					[mm]	⚖️	📦	📦		COMMENTS
	W <sub>1</sub>	W <sub>2</sub>	D <sub>1</sub>	D <sub>2</sub>	H						
A <b>LAV34L</b>	4195	1835	-	1503	1105		262.1	2.129	20		
B <b>LAV35L</b>	4195	1835	-	-	1105		262.1	2.129	20		

DESCRIPTION

⚖️ NET WEIGHT

📦 VOLUME

📦 NUMBER OF PACKAGES

**RECEPTION DESKS SYSTEMS**

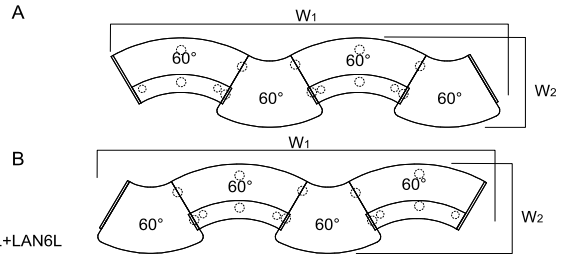
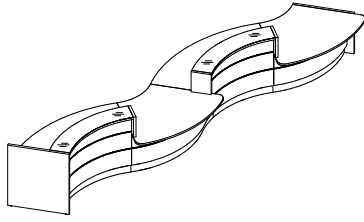

A: LAN1P+LAV62L+NL41+LAN4L+LAV66L+NL41+LAN3P+LAV62L+NL41+LAN4L+LAV66L+LAN6L  
 B: LAN5P+LAV66L+NL41+LAN3P+LAV62L+NL41+LAN4L+LAV66L+NL41+LAN3P+LAV62L+LAN2L

INDEX SYMBOL	DIMENSIONS [mm]						kg	m3	pcs	COMMENTS
	W <sub>1</sub>	W <sub>2</sub>	D <sub>1</sub>	D <sub>2</sub>	H					
A <b>LAV36L</b>	6352	1503	-	-	1105		325.4	2.715	26	
B <b>LAV37L</b>	6352	1503	-	-	1105		325.4	2.715	26	

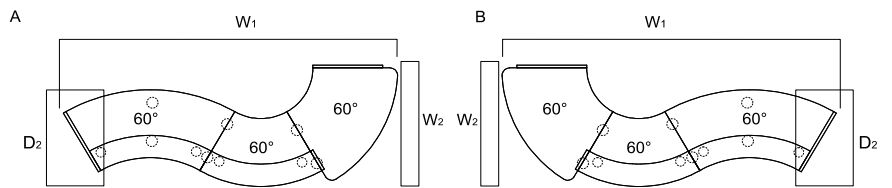
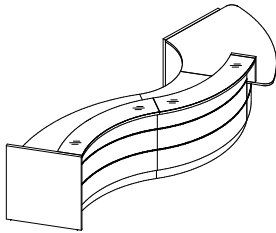

A: LAN1P+LAV62L+NL41+LAV64L+NL41+LAN4L+LAV66L+LAN6L  
 B: LAN5P+LAV66L+NL41+LAN3P+LAV64L+NL41+LAV62L+LAN2L

INDEX SYMBOL	DIMENSIONS [mm]						kg	m3	pcs	COMMENTS
	W <sub>1</sub>	W <sub>2</sub>	D <sub>1</sub>	D <sub>2</sub>	H					
A <b>LAV38L</b>	4386	1639	-	1307	1105		252.3	2.106	19	
B <b>LAV39L</b>	4386	1639	-	-	1105		252.3	2.106	19	

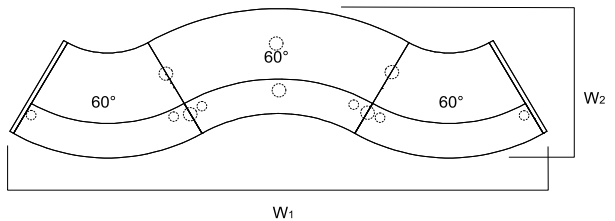
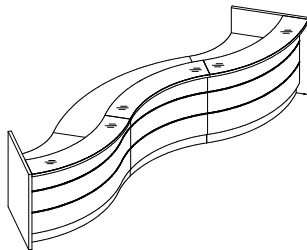

LAN1P+LAV64L+NL41+LAV62L+NL41+LAV64L+LAN2L

INDEX SYMBOL	DIMENSIONS [mm]						kg	m3	pcs	COMMENTS
	W <sub>1</sub>	W <sub>2</sub>	D <sub>1</sub>	D <sub>2</sub>	H					
<b>LAV50L</b>	4566	1307	-	-	1105		269.5	2.345	20	

DESCRIPTION

NET WEIGHT

VOLUME

NUMBER OF PACKAGES

**RECEPTION DESKS SYSTEMS**

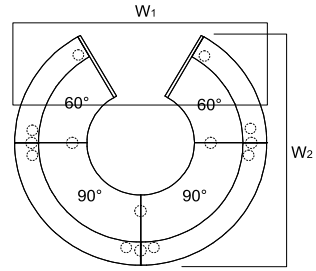
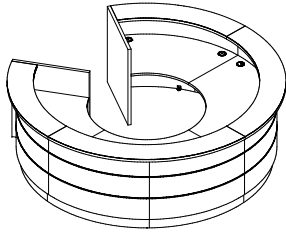

LAN1+LAV64L+NL41+LAV90L+NL41+LAV90L+NL41+LAV64L+LAN2

INDEX SYMBOL	DIMENSIONS					[mm]	⚖️	📦	📦	COMMENTS
	W <sub>1</sub>	W <sub>2</sub>	D <sub>1</sub>	D <sub>2</sub>	H					
<b>LAV51L</b>	3202	3006	-	-	1105		410.0	3.741	27	

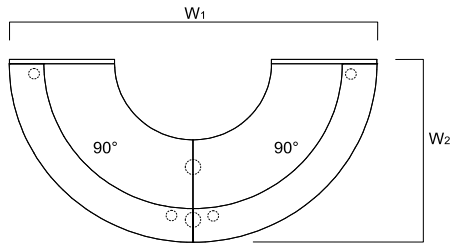
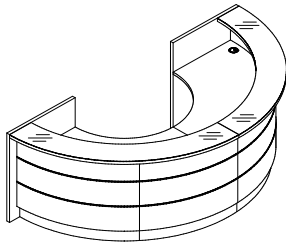

LAN1P+LAV90L+NL41+LAV90L+LAN2L

INDEX SYMBOL	DIMENSIONS					[mm]	⚖️	📦	📦	COMMENTS
	W <sub>1</sub>	W <sub>2</sub>	D <sub>1</sub>	D <sub>2</sub>	H					
<b>LAV52L</b>	3202	1639	-	-	1105		271.0	2.261	15	

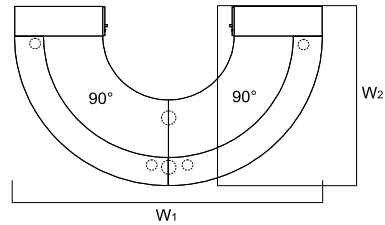
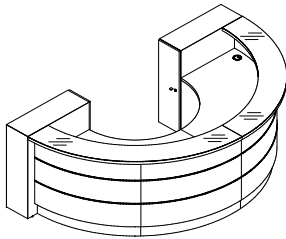

LAD10+LAP10+LAV90L+NL41+LAV90L+LAL10+LAD10

INDEX SYMBOL	DIMENSIONS					[mm]	⚖️	📦	📦	COMMENTS
	W <sub>1</sub>	W <sub>2</sub>	D <sub>1</sub>	D <sub>2</sub>	H					
<b>LAV61L</b>	3202	1919	-	-	1105		328.0	2.909	17	

DESCRIPTION

⚖️ NET WEIGHT

📦 VOLUME

📦 NUMBER OF PACKAGES

**RECEPTION DESKS SYSTEMS**

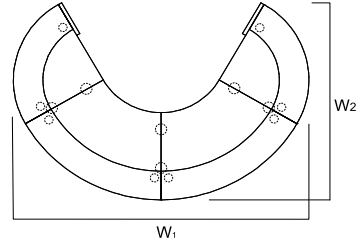
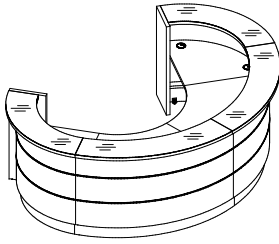

2xLAV70L+2xLAV64L+3xNL41+LAN7P+LAN8L

INDEX SYMBOL	DIMENSIONS [mm]						⚖️	📦	📦	COMMENTS
	W <sub>1</sub>	W <sub>2</sub>	D <sub>1</sub>	D <sub>2</sub>	H		kg	m <sup>3</sup>	pcs	
<b>LAV04L</b>	3202	3006	-	-	1105		250.0	2.312	23	

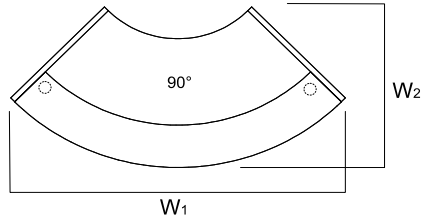
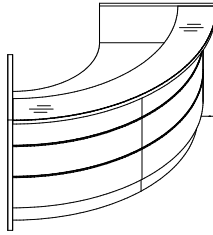

LAN1P+LAV90L+LAN2L

INDEX SYMBOL	DIMENSIONS [mm]						⚖️	📦	📦	COMMENTS
	W <sub>1</sub>	W <sub>2</sub>	D <sub>1</sub>	D <sub>2</sub>	H		kg	m <sup>3</sup>	pcs	
<b>LAV53L</b>	2317	1145	-	-	1105		160.5	1.150	8	

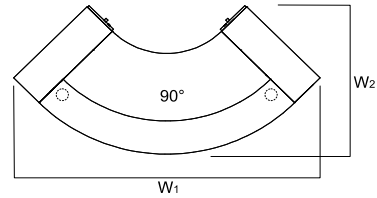
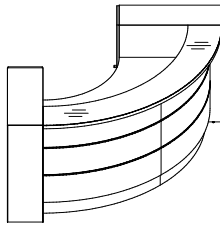

LAD10+LAP10+LAV90L+LAL10+LAD10

INDEX SYMBOL	DIMENSIONS [mm]						⚖️	📦	📦	COMMENTS
	W <sub>1</sub>	W <sub>2</sub>	D <sub>1</sub>	D <sub>2</sub>	H		kg	m <sup>3</sup>	pcs	
<b>LAV73L</b>	2713	1353	-	-	1105		217.5	1.798	10	

DESCRIPTION

⚖️ NET WEIGHT

📦 VOLUME

📦 NUMBER OF PACKAGES

**RECEPTION DESKS SYSTEMS**

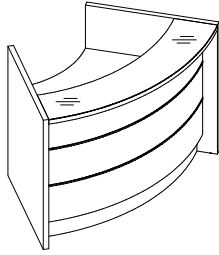

LAN1P+LAV64L+LAN2L

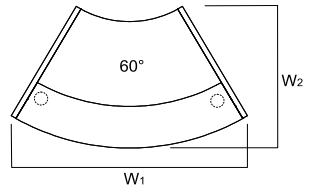

INDEX SYMBOL	DIMENSIONS [mm]									COMMENTS
	W <sub>1</sub>	W <sub>2</sub>	D <sub>1</sub>	D <sub>2</sub>	H		kg	m <sup>3</sup>	pcs	
<b>LAV54L</b>	1666	1029	-	-	1105		119.5	0.779	7	

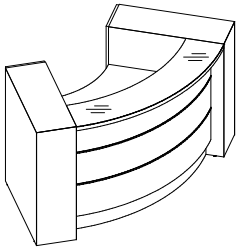

LAD10+LAP10+LAV64L+LAL10+LAD10

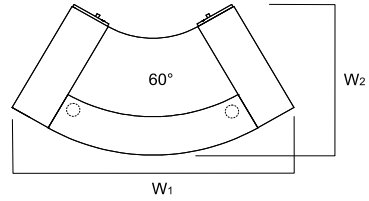

INDEX SYMBOL	DIMENSIONS [mm]									COMMENTS
	W <sub>1</sub>	W <sub>2</sub>	D <sub>1</sub>	D <sub>2</sub>	H		kg	m <sup>3</sup>	pcs	
<b>LAV74L</b>	2151	1183	-	-	1105		176.5	1.427	9	

DESCRIPTION

NET WEIGHT

VOLUME

NUMBER OF PACKAGES

**RECEPTION DESKS SYSTEMS**

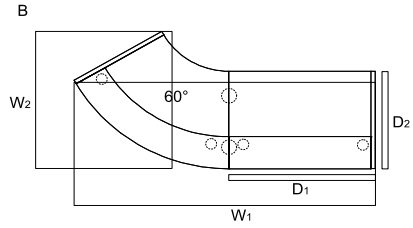
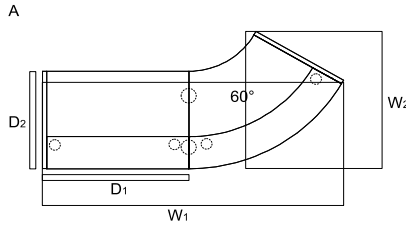
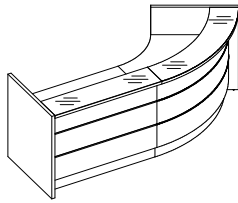

A: LAN1P+LA<sup>13</sup>23L+NL41+LAV64L+LAN2L

B: LAN1P+LAV64L+NL41+LA<sup>16</sup>23L+LAN2L

INDEX SYMBOL	DIMENSIONS [mm]						⚖️	📦	📦		COMMENTS
	W <sub>1</sub>	W <sub>2</sub>	D <sub>1</sub>	D <sub>2</sub>	H						
A LAV78L <sup>13</sup>	2733	1292	1328	917	1105		178.1	1.071	13		
B LAV79L <sup>13</sup>	2733	1292	1328	917	1105		178.1	1.071	13		
A LAV80L <sup>16</sup>	3033	1292	1628	917	1105		191.5	1.118	13		
B LAV81L <sup>16</sup>	3033	1292	1628	917	1105		191.5	1.118	13		
A LAV82L <sup>23</sup>	3733	1292	2318	917	1105		218.0	1.257	14		
B LAV83L <sup>23</sup>	3733	1292	2318	917	1105		218.0	1.257	14		

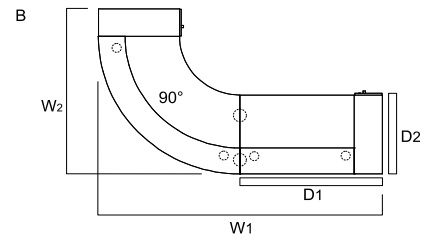
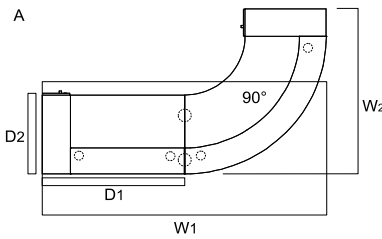
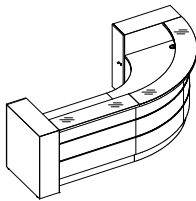

A: LAD10+LAP10+LA<sup>13</sup>16L+NL41+LAV90L+LAL10+LAD10

B: LAD10+LAP10+LAV90L+NL41+LA<sup>13</sup>16L+LAL10+LAD10

INDEX SYMBOL	DIMENSIONS [mm]						⚖️	📦	📦		COMMENTS
	W <sub>1</sub>	W <sub>2</sub>	D <sub>1</sub>	D <sub>2</sub>	H						
A LAV55L <sup>13</sup>	3208	1918	1608	937	1105		276.1	2.089	16		
B LAV56L <sup>13</sup>	3208	1918	1608	937	1105		276.1	2.089	16		
A LAV57L <sup>16</sup>	3508	1918	1908	937	1105		289.5	2.137	16		
B LAV58L <sup>16</sup>	3508	1918	1908	937	1105		289.5	2.137	16		

DESCRIPTION

⚖️ NET WEIGHT

📦 VOLUME

📦 NUMBER OF PACKAGES

**RECEPTION DESKS SYSTEMS**

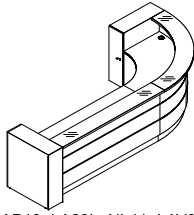

A: LAD10+LAP10+LA23L+NL41+LAV90L+LAL10+LAD10

B: LAD10+LAP10+LAV90L+NL41+LA23L+LAL10+LAD10

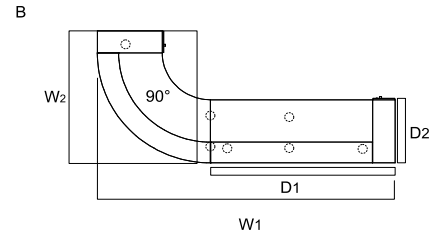
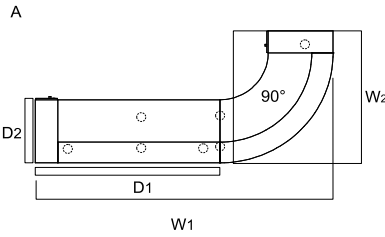

INDEX SYMBOL	DIMENSIONS [mm]						⚖️	📦	📦		COMMENTS
	W <sub>1</sub>	W <sub>2</sub>	D <sub>1</sub>	D <sub>2</sub>	H						
A <b>LAV59L</b>	<sup>23</sup> 4208	1918	2608	937	1105		316.0	2.276	17		
B <b>LAV60L</b>	<sup>23</sup> 4208	1918	2608	937	1105		316.0	2.276	17		

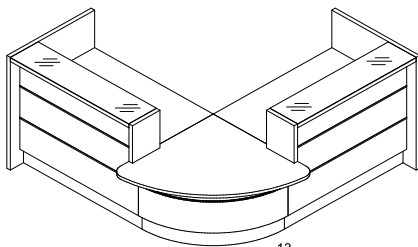

<sup>13</sup> LAN1P+LA16L+NL41+LAN4L+LAV68L+NL41+LAN3P+LA23L+LAN2L

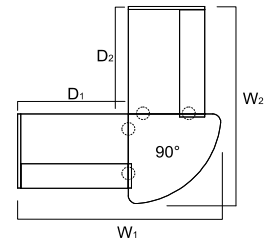

INDEX SYMBOL	DIMENSIONS [mm]						⚖️	📦	📦		COMMENTS
	W <sub>1</sub>	W <sub>2</sub>	D <sub>1</sub>	D <sub>2</sub>	H						
<sup>13</sup> <b>LAV101L</b>	<sup>13</sup> 2437	2437	1328	1328	1105		207.3	0.955	18		
<sup>13</sup> <b>LAV102L</b>	<sup>16</sup> 2437	2737	1328	1628	1105		220.7	1.002	18		
<sup>13</sup> <b>LAV103L</b>	<sup>23</sup> 2437	3437	1328	2318	1105		247.2	1.141	19		
<sup>16</sup> <b>LAV104L</b>	<sup>13</sup> 2737	2437	1628	1328	1105		220.7	1.002	18		
<sup>16</sup> <b>LAV105L</b>	<sup>16</sup> 2737	2737	1628	1628	1105		234.1	1.049	18		
<sup>16</sup> <b>LAV106L</b>	<sup>23</sup> 2737	3437	1628	2318	1105		260.6	1.189	19		

DESCRIPTION

⚖️ NET WEIGHT

📦 VOLUME

📦 NUMBER OF PACKAGES



**RECEPTION DESKS SYSTEMS**

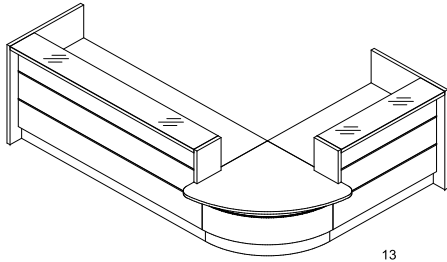

LAN1P+LA23L+NL41+LAN4L+LAV68L+NL41+LAN3P+LA23L+LAN2L  
13  
16

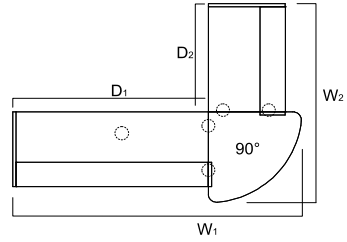

INDEX SYMBOL	DIMENSIONS [mm]						⚖️	📦	📦		COMMENTS
	W <sub>1</sub>	W <sub>2</sub>	D <sub>1</sub>	D <sub>2</sub>	H						
23 <b>LAV107L</b>	13 3437	2437	2318	1328	1105		247.2	1.141	19		
23 <b>LAV108L</b>	16 3437	2737	2318	1628	1105		260.6	1.189	19		
23 <b>LAV109L</b>	23 3437	3437	2318	2318	1105		285.6	1.311	19		

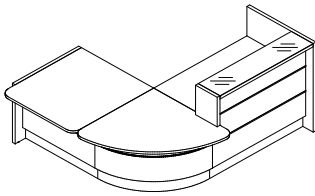

A: LAN5+LAU11L+NL41+LAV68L+NL41+LAN3+LA23L+LAN2  
13  
16  
B: LAN1+LA23L+NL41+LAN4+LAV68L+NL41+LAN11L+LAN6

A

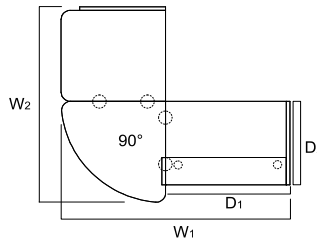

B

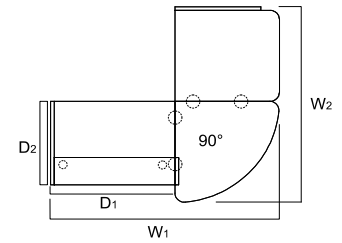

INDEX SYMBOL	DIMENSIONS [mm]						⚖️	📦	📦		COMMENTS
	W <sub>1</sub>	W <sub>2</sub>	D <sub>1</sub>	D <sub>2</sub>	H						
A <b>LAV110L</b>	13 2442	2147	1328	917	1105		176.4	0.832	16		
B <b>LAV111L</b>	13 2442	2147	1328	917	1105		176.4	0.832	16		
A <b>LAV112L</b>	16 2742	2147	1628	917	1105		189.8	0.879	16		
B <b>LAV113L</b>	16 2742	2147	1628	917	1105		189.8	0.879	16		
A <b>LAV114L</b>	23 3442	2147	2318	917	1105		216.3	1.019	17		
B <b>LAV115L</b>	23 3442	2147	2318	917	1105		216.3	1.019	17		

DESCRIPTION

⚖️ NET WEIGHT

📦 VOLUME

📦 NUMBER OF PACKAGES

**RECEPTION DESKS SYSTEMS**

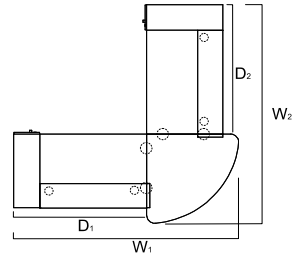
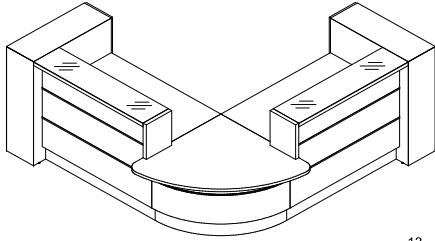

LAD10+LAP10+LA<sup>13</sup>16L+NL41+LAN4L+LAV68L+NL41+LAN3P+LA<sup>13</sup>23L+LAL10+LAD10

INDEX SYMBOL	DIMENSIONS [mm]						⚖️	📦	📦		COMMENTS
	W <sub>1</sub>	W <sub>2</sub>	D <sub>1</sub>	D <sub>2</sub>	H						
<sup>13</sup> LAV116L <sup>13</sup>	2717	2717	1608	1608	1105		264.3	1.603	20		
<sup>13</sup> LAV117L <sup>16</sup>	2717	3017	1608	1908	1105		277.7	1.650	20		
<sup>13</sup> LAV118L <sup>23</sup>	2717	3717	1608	2608	1105		304.2	1.789	21		
<sup>16</sup> LAV119L <sup>13</sup>	3017	2717	1908	1608	1105		277.7	1.650	20		
<sup>16</sup> LAV120L <sup>16</sup>	3017	3017	1908	1908	1105		291.1	1.697	20		
<sup>16</sup> LAV121L <sup>23</sup>	3017	3717	1908	2608	1105		317.6	1.836	21		

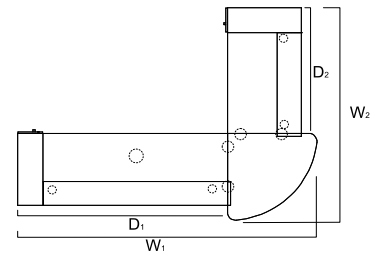
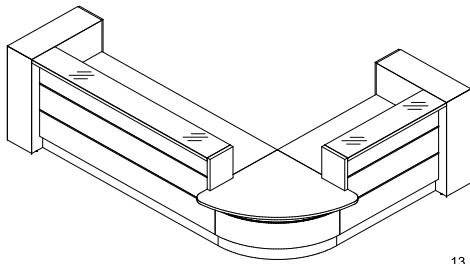

LAD10+LAP10+LA<sup>13</sup>23L+NL41+LAN4L+LAV68L+NL41+LAN3P+LA<sup>13</sup>23L+LAL10+LAD10

INDEX SYMBOL	DIMENSIONS [mm]						⚖️	📦	📦		COMMENTS
	W <sub>1</sub>	W <sub>2</sub>	D <sub>1</sub>	D <sub>2</sub>	H						
<sup>23</sup> LAV122L <sup>13</sup>	3717	2717	2608	1608	1105		304.2	1.789	21		
<sup>23</sup> LAV123L <sup>16</sup>	3717	3017	2608	1908	1105		317.6	1.836	21		
<sup>23</sup> LAV124L <sup>23</sup>	3717	3717	2608	2608	1105		342.6	1.959	21		

DESCRIPTION

⚖️ NET WEIGHT

📦 VOLUME

📦 NUMBER OF PACKAGES

**RECEPTION DESKS SYSTEMS**

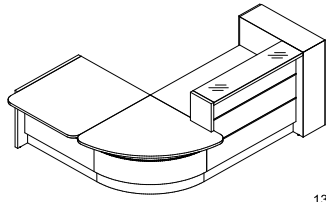

A

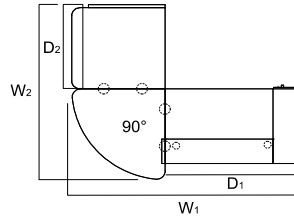

B

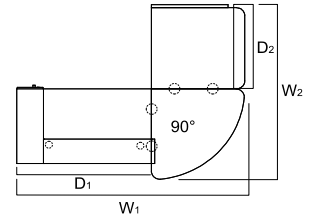

A: LAN5P+LAU11L+NL41+LAV68L+NL41+LAN3+LA23L+LAL10+LAD10

B: LAD10+LAP10+LA23L+NL41+LAN4L+LAV68L+NL41+LAU11L+LAN6L

INDEX SYMBOL	DIMENSIONS [mm]						⚖️	📦	📦		COMMENTS
	W <sub>1</sub>	W <sub>2</sub>	D <sub>1</sub>	D <sub>2</sub>	H						
A <b>LAV125L</b> <sup>13</sup>	2722	2147	1608	1038	1105		209.4	1.167	18		
B <b>LAV126L</b> <sup>13</sup>	2722	2147	1608	1038	1105		204.9	1.156	17		
A <b>LAV127L</b> <sup>16</sup>	3022	2147	1908	1038	1105		218.3	1.203	17		
B <b>LAV128L</b> <sup>16</sup>	3022	2147	1908	1038	1105		214.3	1.197	17		
A <b>LAV129L</b> <sup>23</sup>	3722	2147	2608	1038	1105		244.8	1.343	18		
B <b>LAV130L</b> <sup>23</sup>	3722	2147	2608	1038	1105		244.8	1.343	18		

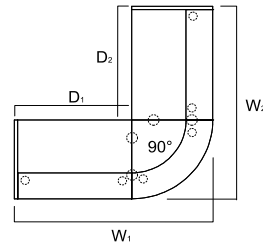
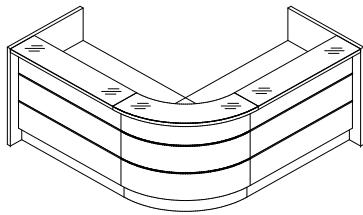

LAN1P+LA13L+NL41+LAV70L+NL41+LA23L+LAN2L

INDEX SYMBOL	DIMENSIONS [mm]						⚖️	📦	📦		COMMENTS
	W <sub>1</sub>	W <sub>2</sub>	D <sub>1</sub>	D <sub>2</sub>	H						
<sup>13</sup> <b>LAV131L</b> <sup>13</sup>	2245	2245	1328	1328	1105		209.7	1.041	17		
<sup>13</sup> <b>LAV132L</b> <sup>16</sup>	2245	2545	1328	1628	1105		223.1	1.088	17		
<sup>13</sup> <b>LAV133L</b> <sup>23</sup>	2245	3245	1328	2318	1105		249.6	1.228	18		

DESCRIPTION

⚖️ NET WEIGHT

📦 VOLUME

📦 NUMBER OF PACKAGES

**RECEPTION DESKS SYSTEMS**

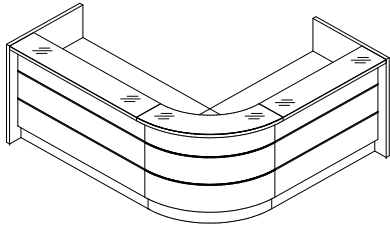

LAN1P+LA16L+NL41+LAV70L+NL41+LA23L+LAN2L  
<sup>13</sup>  
<sup>16</sup>

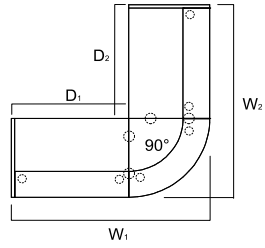

INDEX SYMBOL	DIMENSIONS [mm]						⚖️	📦	📦		COMMENTS
	W <sub>1</sub>	W <sub>2</sub>	D <sub>1</sub>	D <sub>2</sub>	H						
<sup>16</sup> LAV134L <sup>13</sup>	2545	2245	1628	1328	1105		223.1	1.088	17		
<sup>16</sup> LAV135L <sup>16</sup>	2545	2545	1628	1628	1105		236.5	1.136	17		
<sup>16</sup> LAV136L <sup>23</sup>	2545	3245	1628	2318	1105		263.0	1.275	18		

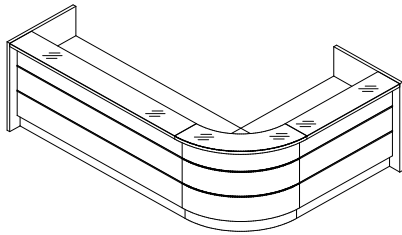

LAN1P+LA23L+NL41+LAV70L+NL41+LA23L+LAN2L  
<sup>13</sup>  
<sup>16</sup>

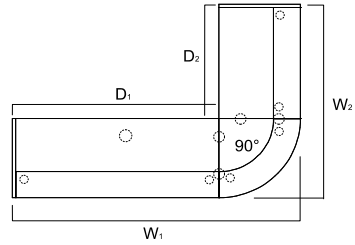

INDEX SYMBOL	DIMENSIONS [mm]						⚖️	📦	📦		COMMENTS
	W <sub>1</sub>	W <sub>2</sub>	D <sub>1</sub>	D <sub>2</sub>	H						
<sup>23</sup> LAV137L <sup>13</sup>	3245	2245	2318	1328	1105		249.6	1.228	18		
<sup>23</sup> LAV138L <sup>16</sup>	3245	2545	2318	1628	1105		263.0	1.275	18		
<sup>23</sup> LAV139L <sup>23</sup>	3245	3245	2318	2318	1105		288.0	1.397	18		

DESCRIPTION

⚖️ NET WEIGHT

📦 VOLUME

📦 NUMBER OF PACKAGES

**RECEPTION DESKS SYSTEMS**

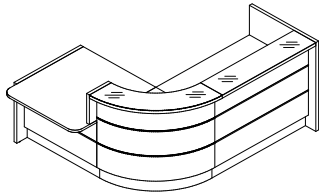

A: LAN5P+LAU11L+NL41+LAN3P+LAV70L+NL41+LA16L+LAN2L<sup>13</sup>

B: LAN1P+LA16L+NL41+LAV70L+NL41+LAN4L+LAU11L+LAN6L<sup>13</sup>

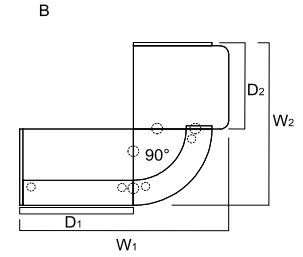
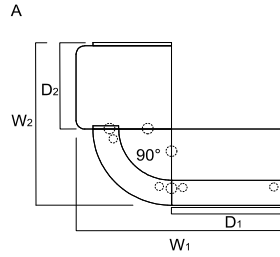

INDEX SYMBOL	DIMENSIONS [mm]						⚖️	📦	📦		COMMENTS
	W <sub>1</sub>	W <sub>2</sub>	D <sub>1</sub>	D <sub>2</sub>	H						
A <b>LAV140L</b> <sup>13</sup>	2442	1955	1328	1038	1105		184.4	0.933	17		
B <b>LAV141L</b> <sup>13</sup>	2442	1955	1328	1038	1105		184.4	0.933	17		
A <b>LAV142L</b> <sup>16</sup>	2742	1955	1628	1038	1105		197.8	0.980	17		
B <b>LAV143L</b> <sup>16</sup>	2742	1955	1628	1038	1105		197.8	0.980	17		

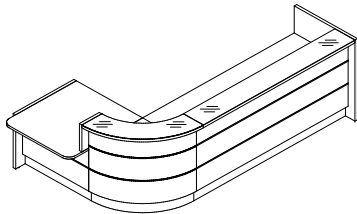

A: LAN5P+LAU11L+NL41+LAN3P+LAV70L+NL41+LA23L+LAN2L

B: LAN1P+LA23L+NL41+LAV70L+NL41+LAN4L+LAU11L+LAN6L

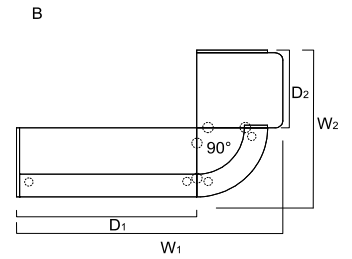
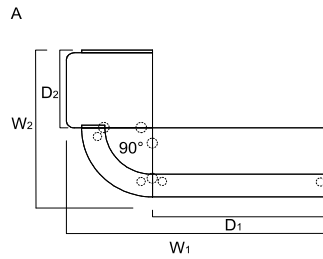

INDEX SYMBOL	DIMENSIONS [mm]						⚖️	📦	📦		COMMENTS
	W <sub>1</sub>	W <sub>2</sub>	D <sub>1</sub>	D <sub>2</sub>	H						
A <b>LAV144L</b> <sup>23</sup>	3442	1955	2318	1038	1105		224.3	1.119	18		
B <b>LAV145L</b> <sup>23</sup>	3442	1955	2318	1038	1105		224.3	1.119	18		

DESCRIPTION

⚖️ NET WEIGHT

📦 VOLUME

📦 NUMBER OF PACKAGES

**RECEPTION DESKS SYSTEMS**

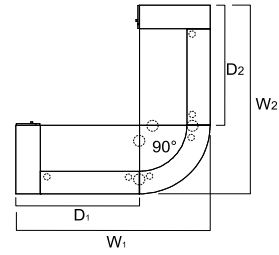
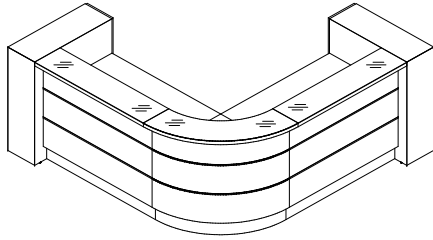

LAD10+LAP10+LA<sup>13</sup><sub>16</sub>L+NL41+LAV70L+NL41+LA<sup>13</sup><sub>23</sub>L+LAL10+LAD10

INDEX SYMBOL	DIMENSIONS [mm]						⚖️	📦	📦		COMMENTS
	W <sub>1</sub>	W <sub>2</sub>	D <sub>1</sub>	D <sub>2</sub>	H						
<sup>13</sup> LAV146L <sup>13</sup>	2525	2525	1608	1608	1105		266.7	1.689	19		
<sup>13</sup> LAV147L <sup>16</sup>	2525	2825	1608	1908	1105		280.1	1.736	19		
<sup>13</sup> LAV148L <sup>23</sup>	2525	3525	1608	2608	1105		306.6	1.875	20		
<sup>16</sup> LAV149L <sup>13</sup>	2825	2525	1908	1608	1105		280.1	1.736	19		
<sup>16</sup> LAV150L <sup>16</sup>	2825	2825	1908	1908	1105		293.5	1.783	19		
<sup>16</sup> LAV151L <sup>23</sup>	2825	3525	1908	2608	1105		320.0	1.923	20		

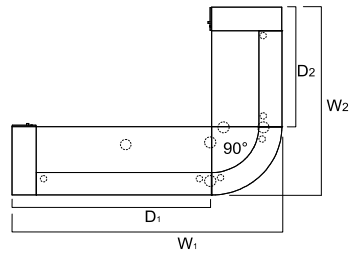
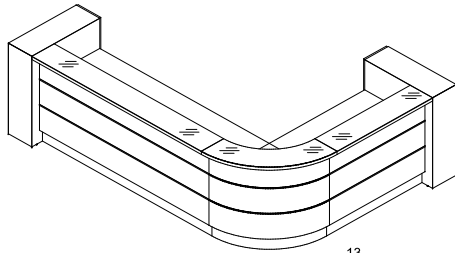

LAD10+LAP10+LA<sup>13</sup><sub>23</sub>L+NL41+LAV70L+NL41+LA<sup>13</sup><sub>23</sub>L+LAL10+LAD10

INDEX SYMBOL	DIMENSIONS [mm]						⚖️	📦	📦		COMMENTS
	W <sub>1</sub>	W <sub>2</sub>	D <sub>1</sub>	D <sub>2</sub>	H						
<sup>23</sup> LAV152L <sup>13</sup>	3525	2525	2608	1608	1105		306.6	1.875	20		
<sup>23</sup> LAV153L <sup>16</sup>	3525	2825	2608	1908	1105		320.0	1.923	20		
<sup>23</sup> LAV154L <sup>23</sup>	3525	3525	2608	2608	1105		345.0	2.045	20		

DESCRIPTION

⚖️ NET WEIGHT

📦 VOLUME

📦 NUMBER OF PACKAGES

**RECEPTION DESKS SYSTEMS**

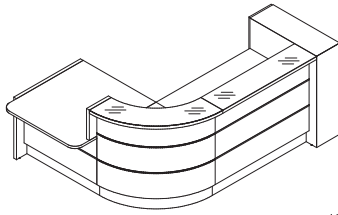

A:

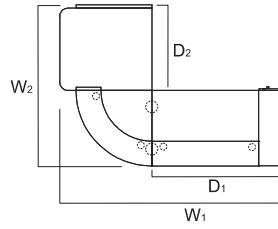

B:

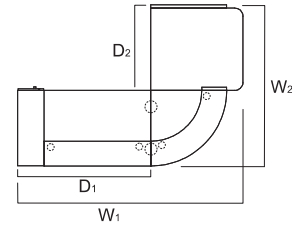

A: LAN5P+LAU11L+NL41+LAN3P+LWC70L+NL41+LW23L+LAL10+LAD10

B: LAD10+LAP10+LW23L+NL41+LWC70L+NL41+LWN4L+LWU11L+LWN6L

INDEX SYMBOL	DIMENSIONS [mm]						kg	m3	pcs	COMMENTS
	W <sub>1</sub>	W <sub>2</sub>	D <sub>1</sub>	D <sub>2</sub>	H					
A <b>LAV155L</b> <sup>13</sup>	2722	1955	1608	1038	1105		217.4	1.268	19	
B <b>LAV156L</b> <sup>13</sup>	2722	1955	1608	1038	1105		217.4	1.268	19	
A <b>LAV157L</b> <sup>16</sup>	3022	1955	1908	1038	1105		226.3	1.304	18	
B <b>LAV158L</b> <sup>16</sup>	3022	1955	1908	1038	1105		222.3	1.298	18	
A <b>LAV159L</b> <sup>23</sup>	3722	1955	2608	1038	1105		252.8	1.443	19	
B <b>LAV160L</b> <sup>23</sup>	3722	1955	2608	1038	1105		252.8	1.443	19	

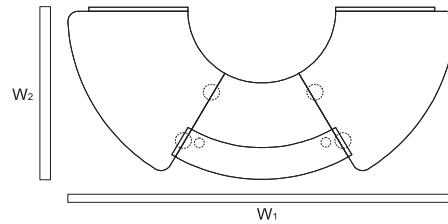
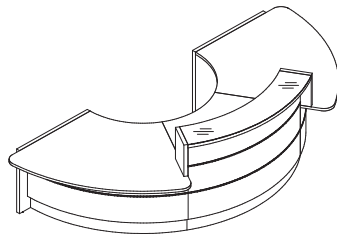

LAN5P+LAV66L+LAN3P+NL41+LAV64L+LAN4L+NL41+LAV66L+LAN6L

INDEX SYMBOL	DIMENSIONS [mm]						kg	m3	pcs	COMMENTS
	W <sub>1</sub>	W <sub>2</sub>	D <sub>1</sub>	D <sub>2</sub>	H					
<b>LAV05L</b>	3589	1629	-	-	1105		224.1	1.781	17	

DESCRIPTION

NET WEIGHT

VOLUME

NUMBER OF PACKAGES

**RECEPTION DESKS SYSTEMS**

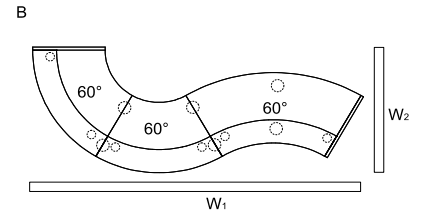
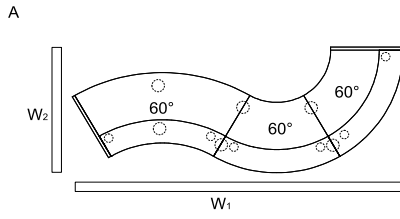
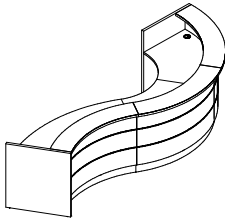

A: LAN1P+LAV62L+NL41+LAV64L+NL41+LAV64L+LAN2L  
 B: LAN1P+LAV64L+NL41+LAV64L+NL41+LAV62L+LAN2L

INDEX SYMBOL	DIMENSIONS [mm]						kg	m3	pcs	COMMENTS
	W <sub>1</sub>	W <sub>2</sub>	D <sub>1</sub>	D <sub>2</sub>	H					
A <b>LAV06L</b>	4199	1629	-	-	1105		269.5	2.345	20	
B <b>LAV07L</b>	4199	1629	-	-	1105		269.5	2.345	20	

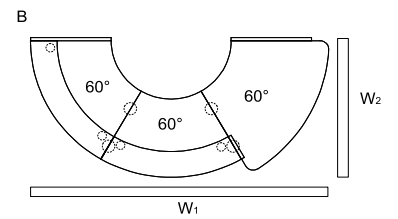
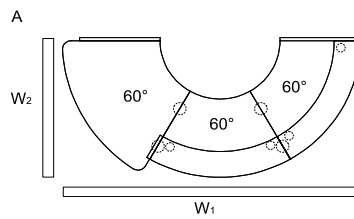
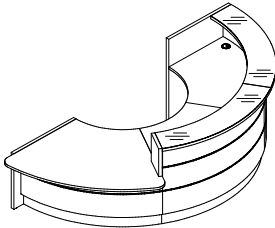

A: LAN5P+LAV66L+NL41+LAN3P+LAV64L+NL41+LAV64L+LAN2L  
 B: LAN1P+LAV64L+NL41+LAV64L+NL41+LAN4L+LAV66L+LAN6L

INDEX SYMBOL	DIMENSIONS [mm]						kg	m3	pcs	COMMENTS
	W <sub>1</sub>	W <sub>2</sub>	D <sub>1</sub>	D <sub>2</sub>	H					
A <b>LAV08L</b>	3367	1629	-	-	1105		235.3	2.009	16	
B <b>LAV09L</b>	3367	1629	-	-	1105		235.3	2.009	16	

DESCRIPTION

NET WEIGHT

VOLUME

NUMBER OF PACKAGES



**RECEPTION DESKS SYSTEMS**

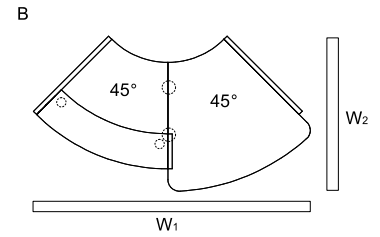
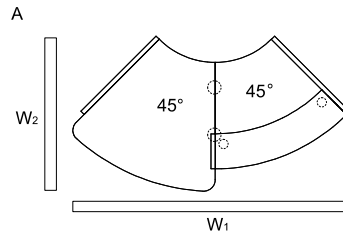
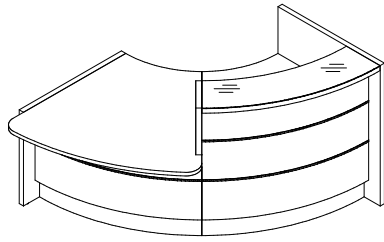

A: LAN5P+LAV65L+NL41+LAN3P+LAV63L+LAN2L

B: LAN1P+LAV63L+NL41+LAN4L+LAV65L+LAN6L

INDEX SYMBOL	DIMENSIONS					[mm]		⚖️	📦	📦	COMMENTS
	W <sub>1</sub>	W <sub>2</sub>	D <sub>1</sub>	D <sub>2</sub>	H						
A <b>LAV161L</b>	2320	1114	-	-	1105			138.8	0.950	11	
B <b>LAV162L</b>	2320	1114	-	-	1105			138.8	0.950	11	

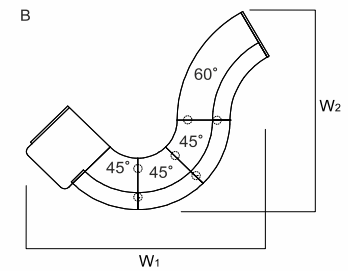
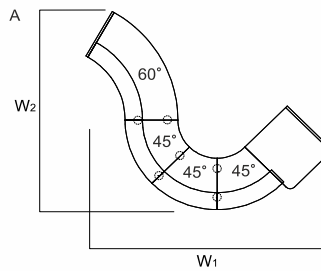
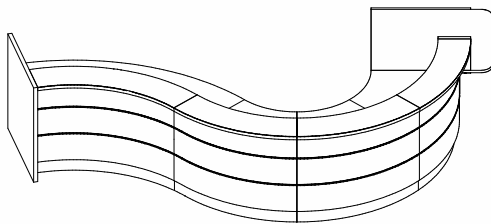

A: LAN6L+LAU11L+LAN4L+3xLAV63L+LAV62L+LAN1P+4xNL41

B: LAN2L+LAV62L+3xLAV63L+LAN3P+LAU11L+LAN5P+4xNL41

INDEX SYMBOL		DIMENSIONS					[mm]		⚖️	📦	📦	COMMENTS
A	B	W <sub>1</sub>	W <sub>2</sub>	D <sub>1</sub>	D <sub>2</sub>	H						
<b>LAV163L</b>	<b>LAV164L</b>	4080	3540	-	-	1105		0.0	0.000	0		

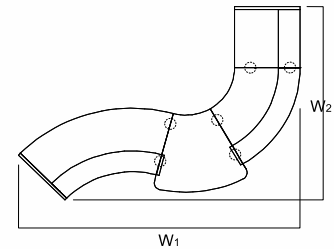
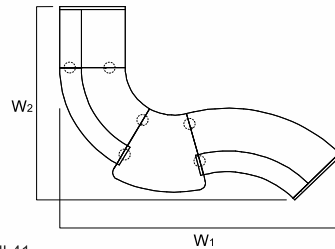
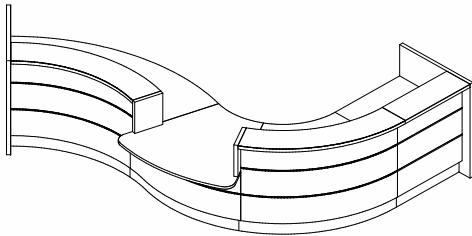

LAN2L+LA09L+LAV63L+LAN3P+LAV65L+LAN4L+LAV62L+LAN1P+3xNL41







INDEX SYMBOL	DIMENSIONS					[mm]		⚖️	📦	📦	COMMENTS
	W <sub>1</sub>	W <sub>2</sub>	D <sub>1</sub>	D <sub>2</sub>	H						
<b>LAV165L</b>	2677	3946	-	-	1105			0.0	0.000	0	

DESCRIPTION

⚖️ NET WEIGHT

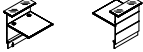
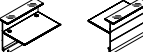
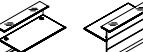
📦 VOLUME

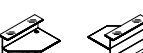
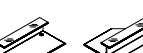
📦 NUMBER OF PACKAGES

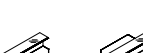

PRODUCT ILLUSTRATION	DIMENSIONS [mm]			INDEX SYMBOL						COMMENTS
	WIDTH	DEPTH	HEIGHT			kg	m3	pcs		
<b>STRAIGHT ELEMENTS</b>										
	844	917	1105	<b>LA09L</b>		37.0	0.153	6		
	1290	917	1105	<b>LA13L</b>		57.6	0.233	7		
	1590	917	1105	<b>LA16L</b>		71.0	0.280	7		
	2290	917	1105	<b>LA23L</b>		97.5	0.419	8		worktop with support leg NE41, 15-high gloss white
	1290	917	1105	<b>LAP13L</b>		56.6	0.233	7		
	1590	917	1105	<b>LAP16L</b>		70.5	0.280	7		
	2290	917	1105	<b>LAP23L</b>		97.0	0.419	8		worktop with support leg NE41, 15-high gloss white
	1290	917	1105	<b>LAL13L</b>		56.6	0.233	7		
	1590	917	1105	<b>LAL16L</b>		70.5	0.280	7		

DESCRIPTION

 NET WEIGHT

 VOLUME

 NUMBER OF PACKAGES

PRODUCT ILLUSTRATION	DIMENSIONS [mm]			INDEX SYMBOL						COMMENTS
	WIDTH	DEPTH	HEIGHT			kg	m3	pcs		

**STRAIGHT ELEMENTS**

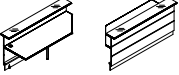
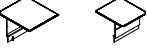







	2290	917	1105	<b>LAL23L</b>		97.0	0.419	8		worktop with support leg NE41, 15-high gloss white
	1000	1114	740	<b>LAU11L</b>		33.5	0.128	5		

DESCRIPTION

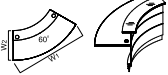
 NET WEIGHT

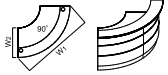
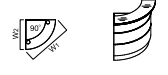
 VOLUME

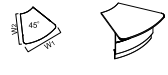
 NUMBER OF PACKAGES

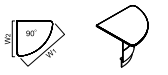

PRODUCT ILLUSTRATION	DIMENSIONS [mm]			INDEX SYMBOL						COMMENTS
	WIDTH	DEPTH	HEIGHT			kg	m3	pcs		
	2216	917	1105	LAV62L		79.5	0.767	8		worktop with support leg NL41, 15-high gloss white
	1600	917	1105	LAV64L		68.5	0.681	7		
	2264	917	1105	LAV90L		137.5	1.128	9		
	1297	917	1105	LAV70L		43.5	0.361	4		
	1225	917	1105	LAV63L		54.5	0.506	6		
	1311	1165	740	LAV65L		35.5	0.291	3		
	1720	1109	740	LAV66L		54.5	0.446	3		
	1485	1109	740	LAV68L		35.5	0.260	3		

DESCRIPTION

 NET WEIGHT

 VOLUME

 NUMBER OF PACKAGES

PRODUCT ILLUSTRATION	DIMENSIONS [mm]			INDEX SYMBOL						COMMENTS
	WIDTH	DEPTH	HEIGHT			kg	m3	pcs		

**COMPOSITION ELEMENTS**

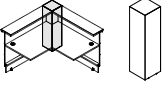
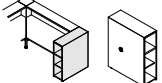
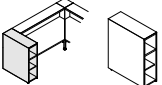
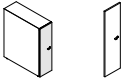
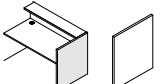
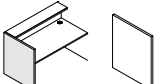
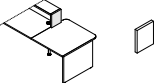
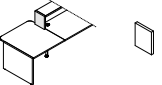
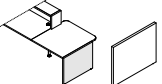

	300	300	1105	<b>LA100</b>		22.2	0.115	1		corner unit
	318	917	1105	<b>LAP10</b>		50.0	0.364	1		end unit with cupboard - right
	318	917	1105	<b>LAL10</b>		50.0	0.364	1		end unit with cupboard - left
	306	20	1088	<b>LAD10</b>		4.5	0.011	1		universal door for LWP10 and LWL10
	38	917	1105	<b>LAN1P</b>		26.0	0.051	1		side panel for high units - right
	38	917	1105	<b>LAN2L</b>		26.0	0.051	1		side panel for high units -left
	38	300	364	<b>LAN3P</b>		2.8	0.007	1		right upper side panel for combining low and high element
	38	300	364	<b>LAN4L</b>		2.8	0.007	1		left upper side panel for combining low and high element
	38	917	740	<b>LAN5P</b>		19.0	0.036	1		right side panel for low unit

DESCRIPTION





 NET WEIGHT

 VOLUME

 NUMBER OF PACKAGES

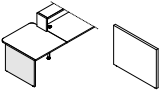
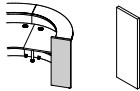
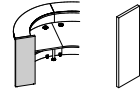
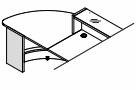
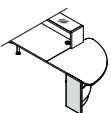
PRODUCT ILLUSTRATION	DIMENSIONS [mm]			INDEX SYMBOL						COMMENTS
	WIDTH	DEPTH	HEIGHT			kg	m3	pcs		

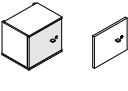
**COMPOSITION ELEMENTS**



	38	917	740	<b>LAN6L</b>		19.0	0.036	1		left side panel for low unit
	38	374	1105	<b>LAN7P</b>		11.0	0.024	1		right side panel for high unit
	38	374	1105	<b>LAN8L</b>		11.0	0.024	1		left side panel for high unit
	38	374	740	<b>LAN9L</b>		7.5	0.013	1		
	38	374	740	<b>LAN9P</b>		7.5	0.013	1		
	345	283	314	<b>LMS05</b>		5.0	0.031	1		
	339	18	286	<b>LMS06</b>		2.0	0.005	1		
	585	142	712	<b>NL41</b>		2.0	0.063	1		round profile leg
	40	40	712	<b>NE41</b>		1.5	0.017	1		round profile leg

DESCRIPTION



 NET WEIGHT

 VOLUME

 NUMBER OF PACKAGES

PRODUCT ILLUSTRATION	DIMENSIONS [mm]			INDEX SYMBOL						COMMENTS
	WIDTH	DEPTH	HEIGHT			kg	m3	pcs		

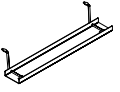
**COMPOSITION ELEMENTS**

	140	70	750	<b>S81</b>		1.1	0.008	1		vertical cable duct in colour 09-aluminum
	460	110	121	<b>E64</b>		0.0	0.000	0		horizontal cable tray 09-aluminum
	580	162	123	<b>S69</b>		1.0	0.015	1		09 - aluminum

DESCRIPTION

 NET WEIGHT

 VOLUME

 NUMBER OF PACKAGES