

SPECIFICATION

Range: **SOCRATE OUTDOOR**

Design: **Mario Trimarchi, Caimi Lab**

Socrate Outdoor refers to a system of modular outdoor furniture. Socrate Outdoor items are designed to be multifunctional and come equipped with accessories for adapting them to any one of the various uses to which they can be put in a given place, be it small or large. Available in a variety of colours, the basic structures, shelves and accessories can be mixed and matched to achieve a personalized chromatic effect.



Codes: **4600E-AN, 4600E-TU, 4800E-AN, 4800E-TU**

Dimensions: 45 x h. 160 cm (4600E-XX)
45 x h. 83 cm (46800E-XX)

Description: Uprights in electro-welded steel rod, galvanized and epoxy powder-coated for outdoor use (colours anthracite grey or pastel turquoise). They are composed of three rods (\varnothing 7mm) aligned on the front and another three (with same characteristics) in the back, joined by pairs of horizontal and inclined rods (\varnothing 6mm) every 19 cm. The uprights are equipped with height adjustable feet in galvanized steel and epoxy powder-coated for outdoor use (colours anthracite grey or pastel turquoise). The feet have holes (\varnothing 6mm) for possible fixing to the floor. The gap between vertical rods is about 5 mm and allows the passage of M4 screws designed to fix crossbars and back parts.

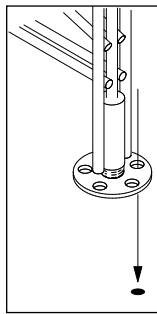

Foot detail
Holes for possible fixing to the floor.

Codes: **4700E-AN, 4700E-TU**

Dimensions: 43 x h. 152,5 cm

Description: back parts in electro-welded steel rod, galvanized and epoxy powder-coated for outdoor use (colours anthracite grey or pastel turquoise). They are composed of two pairs of rods (\varnothing 7mm) aligned on the sides, joined by horizontal and inclined rods (\varnothing 6mm) every 19cm. The back parts are fixed to the uprights by means of M4 screws. They can be fixed together by means of a connector cod. 4750E-I.

Codes: **2940E-AN, 2940E-TU**

Dimensions: L. 45 cm

Description: rear support crossbars consisting of 2 steel rods (\varnothing 8mm) flattened and drilled in the centre and in both ends. Realized in galvanized steel and epoxy powder-coated for outdoors use (colours anthracite grey or pastel turquoise). The rods are fixed to each other and to the uprights with M4 screws and self-locking nuts and washers.

Codes: **4750E-I**

Dimensions: \varnothing 1,2 cm

Description: connector (length 17mm x \varnothing 12mm) in stainless steel for linear connection of two back parts cod. 4700E-XX. The connector is fixed to the back parts with M4 screws and washers.

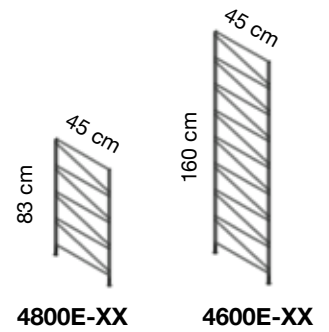

Available colors

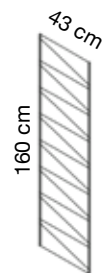
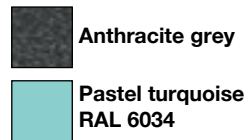

Available colors



4700E-XX



Available colors



2940E-XX

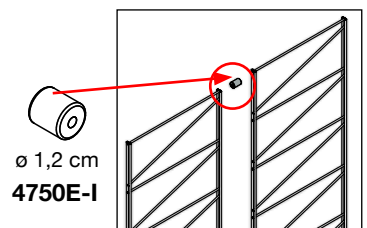

4750E-I

XX=color option

Codes: **4540E-AN, 4540E-TU, 4540E-VO, 4540E-VM**

Dimension: 43 X 43 cm

Description: Shelves in galvanized steel sheet, epoxy powder-coated for outdoor use (colours anthracite grey, pastel turquoise, olive green, green-white).
The shelves are directly assembled on the horizontal rods of the uprights.

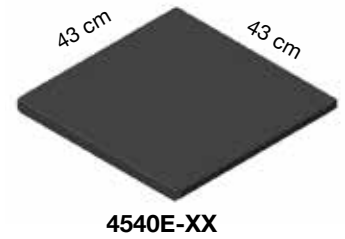
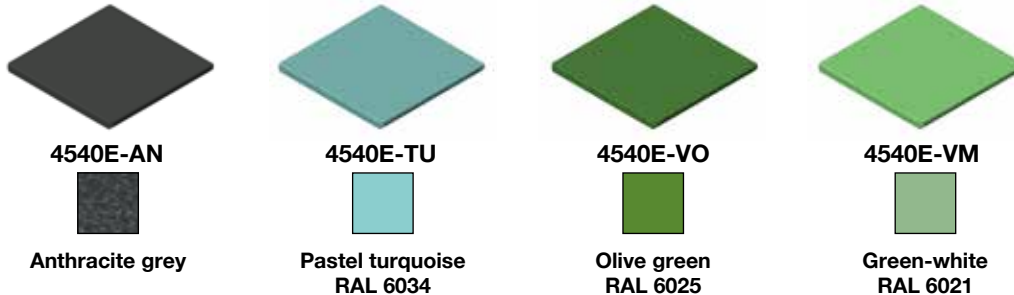

Codes: **4560E-AN, 4560E-TU, 4560E-VO, 4560E-VM**

Dimension: 43 X 43 cm x h. 2 cm

Description: watertight trays in galvanized steel sheet, epoxy powder-coated for outdoor use (colours anthracite grey, pastel turquoise, olive green, green-white).
The shelves are directly assembled on the horizontal or inclined rods of the uprights.

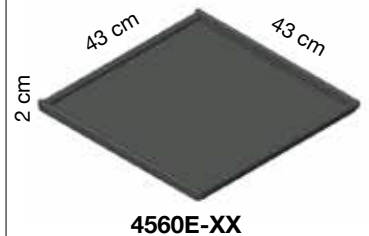
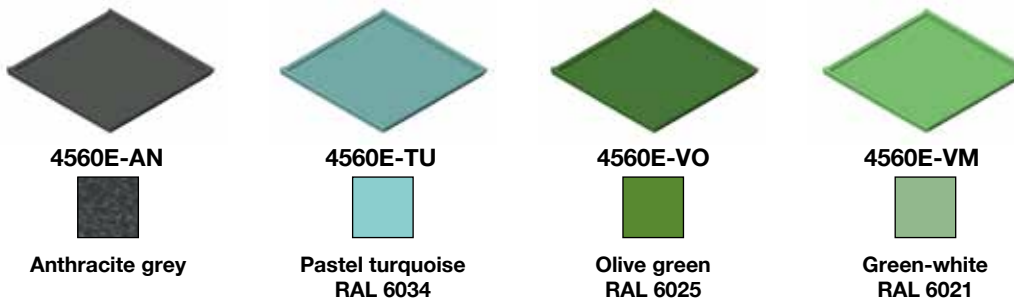

Codes: **4570E-AN, 4570E-TU, 4570E-VO, 4570E-VM**

Dimension: 43 X 43 cm x h. 6,5

Description: trays in galvanized steel sheet, epoxy powder-coated for outdoor use (colours anthracite grey, pastel turquoise, olive green, green-white).
The shelves are directly assembled on the horizontal or inclined rods of the uprights.

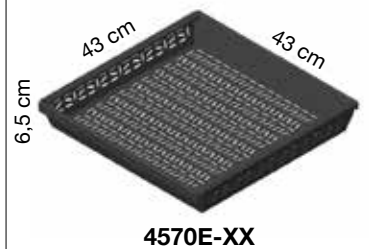
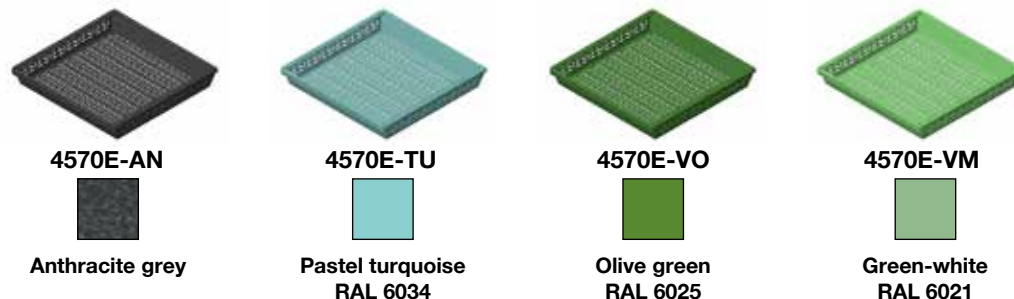

XX = color option

Codes: **4530E-AN, 4530E-TU, 4530E-VO, 4530E-VM**

Dimension: L. 39,5 cm, P 17 cm, H. 25,5 cm, H. mensola 6,5 cm

Description: shelves in galvanized steel sheet, epoxy powder-coated for outdoor use (colours anthracite grey, pastel turquoise, olive green, green-white).
The shelves are directly assembled on the horizontal rods of the uprights.

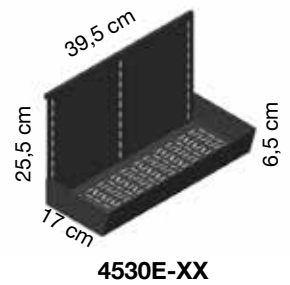

4530E-AN



Anthracite grey

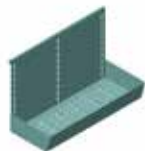

4530E-TU



**Pastel turquoise
RAL 6034**

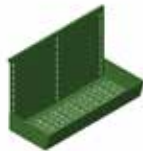

4530E-VO



**Olive green
RAL 6025**

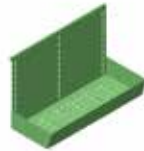

4530E-VM



**Green-white
RAL 6021**

Codes: **4510E-AN, 4510E-TU**

Dimension: 43 X 43 cm x H 3 cm

Description: Undercounter in galvanized steel sheet, epoxy powder-coated for outdoor use (colours anthracite grey, pastel turquoise).
The undercounters are directly assembled on the horizontal rods of the uprights. The undercounter allows the end user to select their own custom top to be positioned on the undercounter (for example in wood or marble).

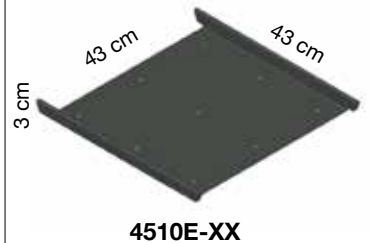

4510E-AN



Anthracite grey



4510E-TU



**Pastel turquoise
RAL 6034**

Codes: **4520E-ANS, 4520E-TUS, 4520E-ANC, 4520E-TUC**

Dimension: 43 X 43 cm x H 3 cm

Description: shelves in brushed Serizzo granite or polished Carrara marble, fixed by screws to undercounters in perforated galvanized steel sheet, epoxy powder-coated for outdoor use (colours anthracite grey, pastel turquoise). The shelves are directly assembled on the horizontal rods of the uprights.

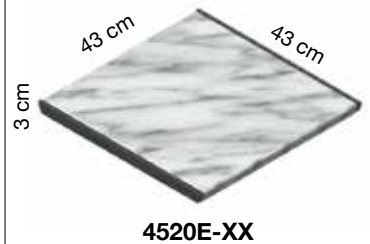

4520E-ANS



Granito Serizzo

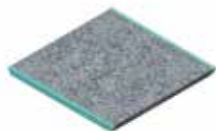

4520E-TUS



Granito Serizzo

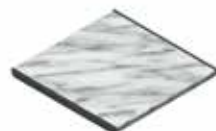

4520E-ANC



Granito Serizzo

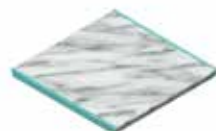

4520E-TUC



Granito Serizzo



Anthracite grey



**Pastel turquoise
RAL 6034**



Anthracite grey



**Pastel turquoise
RAL 6034**

XX = color option

Codes: **4580E-AN, 4580E-TU**

Dimension: 43 X 43 cm

Description: shelves in steel rod and galvanized steel sheet, epoxy powder-coated for outdoor use (colours anthracite grey, pastel turquoise).
The shelves are directly assembled on the horizontal rods of the uprights.



4580E-AN



Anthracite grey



4580E-TU



**Pastel turquoise
RAL 6034**

Code: **4590E-IS**

Dimension: 39 x 38,5 cm x H 42 cm

Description: container in AISI 304 scotch-brite stainless steel, equipped with one-way wheels.
Can be equipped with separator cod. 4591E-IS

Code: **4591E-IS**

Dimension: 38 x H 36 cm

Description: separator in AISI 304 scotch-brite stainless steel for code 4590E-IS

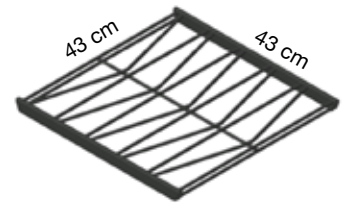

4580E-XX

XX = color option

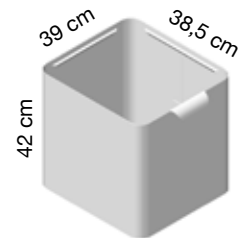

4590E-IS

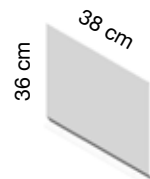

4591E-IS

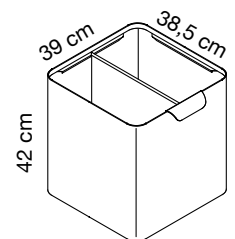

4590E-IS + 4591E-IS



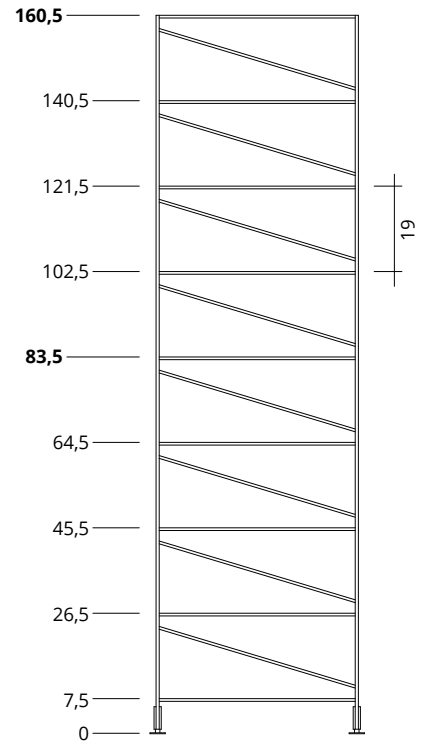
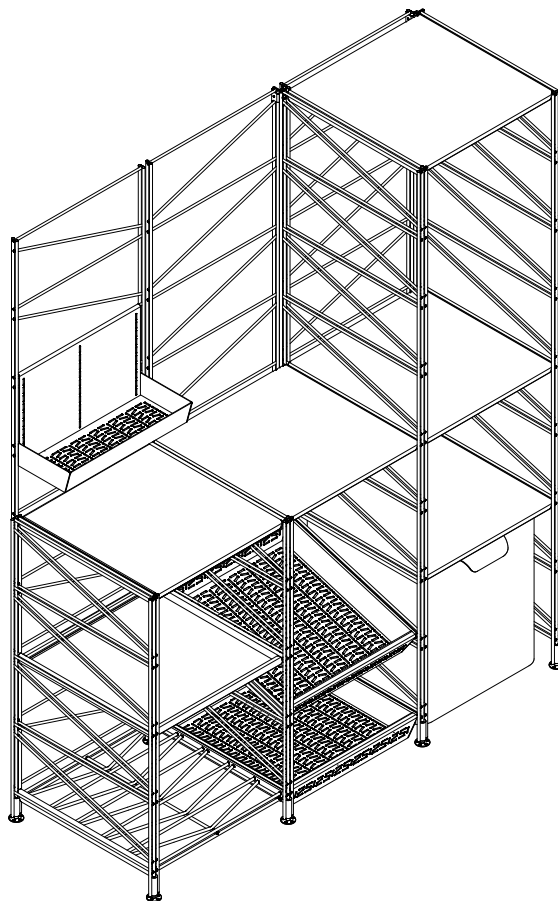

Acciaio zincato e verniciato con polveri epossidiche per esterni.
Galvanized and epoxy-powder coated steel for outdoor use.

RESISTENZA ALLA CORROSIONE
CORROSION TEST
NSS UNI EN ISO 9227:2017
Ore di esposizione / Hours of exposure
800

2940E



4700E

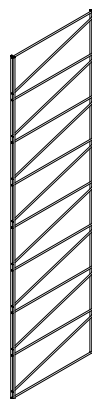

H 160

MIN	MAX	MIN	MAX
1	2	1	1

H 83

MIN	MAX	MIN	MAX
1	1	1	1

